

CANDY

MIC 20G DFX
MIC 20G DFN

MICROWAVE OVENS
USER INSTRUCTIONS

GB

FOURS A MICRO-ONDES
MANUEL D'INSTRUCTIONS

FR

FORNI A MICROONDE
MANUALE DI ISTRUZIONI

IT

MIKROWELLENHERD
BEDIENUNGSANWEISUNG

DE

أفران الميكروويف
تعليمات المستخدم

العربية



Microwave Oven
INSTRUCTION MANUAL
MODEL: MIC 20G DFX
MIC 20G DFN

Read these instructions carefully before using your microwave oven, and keep it carefully.

If you follow the instructions, your oven will provide you with many years of good service.

SAVE THESE INSTRUCTIONS CAREFULLY

PRECAUTIONS TO AVOID POSSIBLE EXPOSURE TO EXCESSIVE MICROWAVE ENERGY

- (a) Do not attempt to operate this oven with the door open since this can result in harmful exposure to microwave energy. It is important not to break or tamper with the safety interlocks.
- (b) Do not place any object between the oven front face and the door or allow soil or cleaner residue to accumulate on sealing surfaces.
- (c) **WARNING:** If the door or door seals are damaged, the oven must not be operated until it has been repaired by a competent person.

ADDENDUM

If the apparatus is not maintained in a good state of cleanliness, its surface could be degraded and affect the lifespan of the apparatus and lead to a dangerous situation.

Specifications

Model:	MIC 20G DFX MIC 20G DFN
Rated Voltage:	230V~50Hz
Rated Input Power(Microwave):	1250W
Rated Output Power(Microwave):	800W
Rated Input Power(Grill):	1000W
Oven Capacity:	20L
Turntable Diameter:	Ø245mm
External Dimensions:	594x345x388mm
Net Weight:	Approx. 15 kg

IMPORTANT SAFETY INSTRUCTIONS

WARNING

To reduce the risk of fire, electric shock, injury to persons or exposure to excessive microwave oven energy when using your appliance, follow basic precautions, including the following:

1. Warning: Liquids and other foods must not be heated in sealed containers since they are liable to explode.
2. Warning: It is hazardous for anyone other than a competent person to carry out any service or repair operation that involves the removal of a cover which gives protection against exposure to microwave energy.
3. This appliance can be used by children aged from 8 years and above and persons with reduced physical, sensory or mental capabilities or lack of experience and knowledge if they have been given supervision or instruction concerning use of the appliance in a safe way and understand the hazards involved. Children shall not play with the appliance. Cleaning and user maintenance shall not be made by children unless they are older than 8 and supervised.
4. Keep the appliance and its cord out of reach of children less than 8 years.
5. Only use utensils suitable for use in microwave ovens.
6. The oven should be cleaned regularly and any food deposits should be removed.
7. Read and follow the specific: "PRECAUTIONS TO AVOID POSSIBLE EXPOSURE TO EXCESSIVE MICROWAVE ENERGY".
8. When heating food in plastic or paper containers, keep an eye on the oven due to the possibility of ignition.

9. If smoke is emitted, switch off or unplug the appliance and keep the door closed in order to stifle any flames.
10. Do not overcook food.
11. Do not use the oven cavity for storage purposes. Do not store items, such as bread, cookies, etc. inside the oven.
12. Remove wire twist-ties and metal handles from paper or plastic containers/bags before placing them in the oven.
13. Install or locate this oven only in accordance with the installation instructions provided.
14. Eggs in the shell and whole hard-boiled eggs should not be heated in microwave ovens since they may explode, even after microwave heating has ended.
15. This appliance is intended to be used in household and similar applications such as:
 - staff kitchen areas in shops, offices and other working environments;
 - by clients in hotels, motels and other residential type environments;
 - farm houses;
 - bed and breakfast type environments.
16. If the supply cord is damaged, it must be replaced by the manufacturer, its service agent or similarly qualified persons in order to avoid a hazard.
17. Do not store or use this appliance outdoors.
18. Do not use this oven near water, in a wet basement or near a swimming pool.
19. The temperature of accessible surfaces may be high when the appliance is operating. The surfaces are liable to get hot during use. Keep cord away from heated surface, and do not cover any vents on the oven.

20. Do not let cord hang over edge of table or counter.
21. Failure to maintain the oven in a clean condition could lead to deterioration of the surface that could adversely affect the life of the appliance and possibly result in a hazardous situation.
22. The contents of feeding bottles and baby food jars shall be stirred or shaken and the temperature checked before consumption, in order to avoid burns.
23. Microwave heating of beverages can result in delayed eruptive boiling, therefore care must be taken when handling the container.
24. The appliance is not intended for use by persons (including children) with reduced physical, sensory or mental capabilities, or lack of experience and knowledge, unless they have been given supervision or instruction concerning use of the appliance by a person responsible for their safety.
25. Children should be supervised to ensure that they do not play with the appliance.
26. The appliances are not intended to be operated by means of an external timer or separate remote-control system.
27. Accessible parts may become hot during use. Young children should be kept away.
28. Steam cleaner is not to be used.
29. During use the appliance becomes hot. Care should be taken to avoid touching heating elements inside the oven.
30. Only use the temperature probe recommended for this oven. (for ovens provided with a facility to use a temperature-sensing probe.)

31. WARNING: The appliance and its accessible parts become hot during use. Care should be taken to avoid touching heating elements. Children less than 8 years of age shall be kept away unless continuously supervised.
32. The microwave oven must be operated with the decorative door open. (for ovens with a decorative door.)
33. Surface of a storage cabinet can get hot.

READ CAREFULLY AND KEEP FOR FUTURE REFERENCE

To Reduce the Risk of Injury to Persons Grounding Installation

DANGER

Electric Shock Hazard
Touching some of the internal components can cause serious personal injury or death. Do not disassemble this appliance.

WARNING

Electric Shock Hazard Improper use of the grounding can result in electric shock. Do not plug into an outlet until appliance is properly installed and grounded.

This appliance must be grounded. In the event of an electrical short circuit, grounding reduces the risk of electric shock by providing an escape wire for the electric current. This appliance is equipped with a cord having a grounding wire with a grounding plug. The plug must be plugged into an outlet that is properly installed and grounded.

Consult a qualified electrician or serviceman if the grounding instructions are not completely understood or if doubt exists as to whether the appliance is properly grounded. If it is necessary to use an extension cord, use only a 3-wire

1. A short power-supply cord is provided to reduce the risks resulting from becoming entangled in or tripping over a longer cord.
2. If a long cord set or extension cord is used:
 - 1) The marked electrical rating of the cord set or extension cord should be at least as great as the electrical rating of the appliance.
 - 2) The extension cord must be a grounding-type 3-wire cord.
 - 3) The long cord should be arranged so that it will not drape over the counter top or tabletop where it can be pulled on by children or tripped over unintentionally.

CLEANING

Be sure to unplug the appliance from the power supply.

1. Clean the cavity of the oven after using with a slightly damp cloth.
2. Clean the accessories in the usual way in soapy water.
3. The door frame and seal and neighbouring parts must be cleaned carefully with a damp cloth when they are dirty.
4. Do not use harsh abrasive cleaners or sharp metal scrapers to clean the oven door glass since they can scratch the surface, which may result in shattering of the glass.
5. Cleaning Tip---For easier cleaning of the cavity walls that the food cooked can touch: Place half a lemon in a bowl, add 300ml (1/2 pint) water and heat on 100% microwave power for 10 minutes. Wipe the oven clean using a soft, dry cloth.

UTENSILS

CAUTION

Personal Injury Hazard

It is hazardous for anyone other than a competent person to carry out any service or repair operation that involves the removal of a cover which gives protection against exposure to microwave energy.

See the instructions on "Materials you can use in microwave oven or to be avoided in microwave oven."

There may be certain non-metallic utensils that are not safe to use for microwaving. If in doubt, you can test the utensil in question following the procedure below.

Utensil Test:

1. Fill a microwave-safe container with 1 cup of cold water (250ml) along with the utensil in question.
2. Cook on maximum power for 1 minute.
3. Carefully feel the utensil. If the empty utensil is warm, do not use it for microwave cooking.
4. Do not exceed 1 minute cooking time.

Materials you can use in microwave oven

Utensils	Remarks
Aluminum foil	Shielding only. Small smooth pieces can be used to cover thin parts of meat or poultry to prevent overcooking. Arcing can occur if foil is too close to oven walls. The foil should be at least 1 inch (2.5cm) away from oven walls.
Browning dish	Follow manufacturer's instructions. The bottom of browning dish must be at least 3/16 inch (5mm) above the turntable. Incorrect usage may cause the turntable to break.
Dinnerware	Microwave-safe only. Follow manufacturer's instructions. Do not use cracked or chipped dishes.
Glass jars	Always remove lid. Use only to heat food until just warm. Most glass jars are not heat resistant and may break.
Glassware	Heat-resistant oven glassware only. Make sure there is no metallic trim. Do not use cracked or chipped dishes.
Oven cooking bags	Follow manufacturer's instructions. Do not close with metal tie. Make slits to allow steam to escape.
Paper plates and cups	Use for short-term cooking/warming only. Do not leave oven unattended while cooking.
Paper towels	Use to cover food for reheating and absorbing fat. Use with supervision for a short-term cooking only.
Parchment paper	Use as a cover to prevent splattering or a wrap for steaming.
Plastic	Microwave-safe only. Follow the manufacturer's instructions. Should be labeled "Microwave Safe". Some plastic containers soften, as the food inside gets hot. "Boiling bags" and tightly closed plastic bags should be slit, pierced or vented as directed by package.
Plastic wrap	Microwave-safe only. Use to cover food during cooking to retain moisture. Do not allow plastic wrap to touch food.
Thermometers	Microwave-safe only (meat and candy thermometers).
Wax paper	Use as a cover to prevent splattering and retain moisture.

Materials to be avoided in microwave oven

Utensils	Remarks
Aluminum tray	May cause arcing. Transfer food into microwave-safe dish.
Food carton with metal handle	May cause arcing. Transfer food into microwave-safe dish.
Metal or metal-trimmed utensils	Metal shields the food from microwave energy. Metal trim may cause arcing.
Metal twist ties	May cause arcing and could cause a fire in the oven.
Paper bags	May cause a fire in the oven.
Plastic foam	Plastic foam may melt or contaminate the liquid inside when exposed to high temperature.
Wood	Wood will dry out when used in the microwave oven and may split or crack.

SETTING UP YOUR OVEN

Names of Oven Parts and Accessories

Remove the oven and all materials from the carton and oven cavity.

Your oven comes with the following accessories:

- Glass tray 1
- Turntable ring assembly 1
- Instruction Manual 1

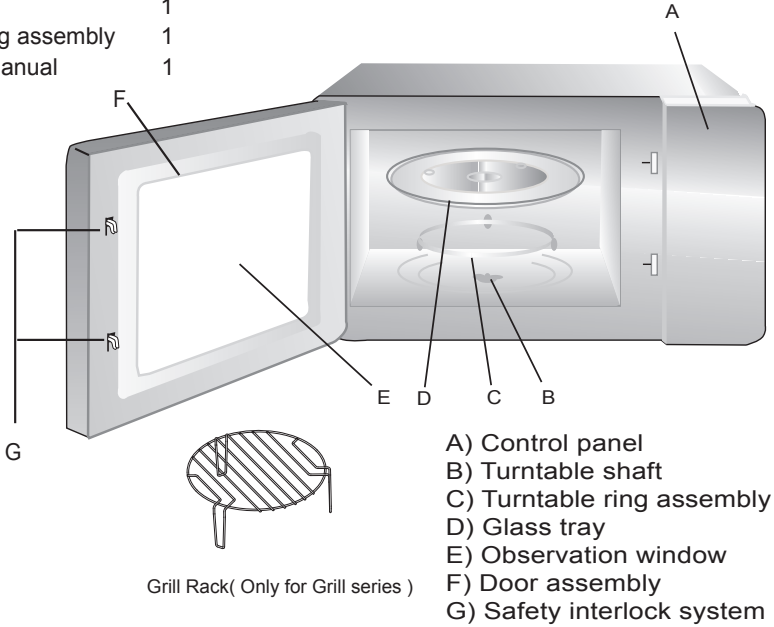

Turntable Installation

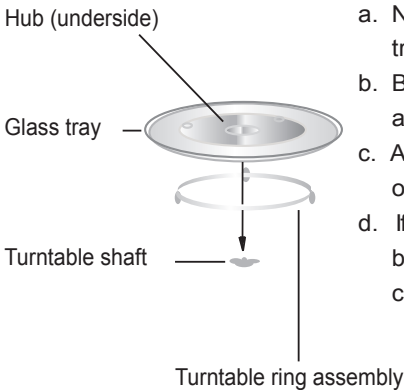

- a. Never place the glass tray upside down. The glass tray should never be restricted.
- b. Both glass tray and turntable ring assembly must always be used during cooking.
- c. All food and containers of food are always placed on the glass tray for cooking.
- d. If glass tray or turntable ring assembly cracks or breaks, contact your nearest authorized service center.

Installation and connection

- 1.This appliance is only intended for domestic use.
- 2.This oven is intended for built-in use only.It is not intended for counter-top use or for use inside a cupboard.
3. Please observe the special installation instructions.
- 4.The appliance can be installed in a 60cm wide wall-mounted cupboard(at least 55cm deep and 85cm off the floor).
- 5.The appliance is fitted with a plug and must only be connected to a properly installed earthed socket.
- 6.The mains voltage must correspond to the voltage specified on the rating plate.
- 7.The socket must be installed and connecting cable must only be replaced by a qualified electrician.If the plug is no longer to accessible following installation,an all-pole disconnecting device must be present on the installation side with a contact gap of at least 3mm.
- 8.Adapters,multi-way strips and extension leads must not be used. Overloading can result in a risk of fire.



The accessible surface may be hot during operation.





Operation Instructions

1. Clock Setting

When the microwave oven is electrified, the LED will display "0:00", buzzer will ring once.

1) Press " | ", the hour figures will flash.

2) Turn "" to adjust the hour figures, the input time should be within 0--23.

3) Press " | ", the minute figures will flash.

4) Turn "" to adjust the minute figures, the input time should be within 0--59.







5) Press " | " to finish clock setting. ":" will flash, and the time will light.

Note: 1) If the clock is not set, it would not function when powered.



2) During the process of clock setting, if you press " STOP", the oven will go back to the previous status automatically.





2. Microwave Cooking

Press " |  | ", the LED will display "P100. Press

" |  | " for times or turn "" to choose the power you want, and "P100", "P80" "P50", "P30" or "P10" will display for each added press. Then press " +30" to confirm, and turn "" to set cooking time from 0:05 to 95:00. Press " +30" again to start cooking.

Example: If you want to use 80% microwave power to cook for 20 minutes, you can operate the oven as the following steps.

1) Press " |  | " once, the screen display "P100".

2) Press " |  | " once again or turn "" to choose 80% microwave power.



3) Press " +30" to confirm, and the screen displays "P 80".

4) Turn "" to adjust the cooking time until the oven displays "20:00".



5) Press " +30" to start cooking .







Note: the step quantities for the adjustment time of the coding switch are as follow:

0---1 min	:	5 seconds
1---5 min	:	10 seconds
5---10 min	:	30 seconds
10---30 min	:	1 minute
30---95 min	:	5 minutes



"    " Order	Pad instructions Display	Microwave Power	Grill Power
1	P100	100%	
2	P80	80%	
3	P50	50%	
4	P30	30%	
5	P10	10%	
6	G	0%	100%
7	C-1	55%	45%
8	C-2	36%	64%

3. Grill or Combi. Cooking

Press "  |  |  " once, "P100" displays and then press

"  |  |  " for times or turn the "  " to choose the power you want, and "G", "C-1" or "C-2" will display for each added press. Then press "  +30" "to confirm, and turn "  " to set cooking time from 0:05 to 95:00. Press "  +30" " again to start cooking.

Example: If you want to use 55% microwave power and 45% grill power(C-1) to cook for 10 minutes, you can operate the oven as the following steps.

1) Press "  |  |  " once, the screen display "P100".

2) Press "  |  |  " times or turn "  " to choose combi. 1 mode.

3) Press "  +30" " to confirm, and the screen displays "C-1".





4) Turn "  " to adjust the cooking time until the oven displays "10:00".

5) Press "  +30" " to start cooking .



Note: If half the grill time passes, the oven sounds twice, and this is normal.

In order to have a better effect of grilling food, you should turn the food over, close the door, and then if no operation the oven will continue cooking.

4. Quick Start

- 1) In waiting state, Press " +30" " to start cooking with 100% power, each added press will increase 30 seconds cooking time up to 95 minutes.
- 2) In microwave, grill, combi. cooking or time defrost state, each press of " +30" " can increase 30 seconds of cooking time.
- 3) In waiting state, turn " " anti-clockwise to set cooking time with 100% microwave power, then press " +30" " to start cooking.



5. Defrost By Weight

- 1) Press " |  " once, and the oven will display "dEF1".

- 2) Turn " " to select the weight of food from 100 to 2000 g.

- 3) Press " +30" " to start defrosting.

6. Defrost By Time

- 1) Press " |  " twice, and the oven will display "dEF2".

- 2) Turn " " to select the defrost time.



- 3) Press " +30" " to start defrosting.

7. Auto Menu

- 1) Turn " " right to choose the menu, and "A-1" to "A-10" will display, which means pizza, potato, meat, fish,vegetable, beverage, pasta, popcorn,chicken and reheat.

 - 2) Press " +30" " to confirm.

 - 3) Turn " " to choose the default weight as the menu chart.

 - 4) Press " +30" " to start cooking.
- Example: If you want to use "Auto Menu" to cook fish for 350g.
- 1) Turn " " clockwise till "A-4" display.

 - 2) Press " +30" " to confirm.

 - 3) Turn " " to select the weight of fish till "350" display.

 - 4) Press " +30" " to start cooking.

The menu chart:

Menu	Weight	Display
A-1 Pizza	200 g	200 g
	400 g	400 g
A-2 Potato	200 g	200 g
	400 g	400 g
	600 g	600 g
A-3 Meat	250 g	250 g
	350 g	350 g
	450 g	450 g
A-4 Fish	250 g	250 g
	350 g	350 g
	450 g	450 g
A-5 Vegetable	200 g	200 g
	300 g	300 g
	400 g	400 g
A-6 Beverage	1cup(120ml)	1
	2cup(240ml)	2
	3cup(360ml)	3
A-7 Pasta	50g(with 450ml cold water)	50g
	100g(with 800ml cold water)	100g
A-8 Popcorn	50g	50g
	100g	100g
A-9 Chicken	200g	200g
	400g	400g
	600g	600g
	800g	800g
A-10 Reheat	200g	200g
	400g	400g
	600g	600g

8. Program set in Advance





1) Set the clock first. (Consult the instruction of clock setting.)



2) Input the cooking program. Two stages can be set at most.



Defrost should not be set as the cooking program.

Example: If you want to cook with 80% microwave power for 7 minutes, operate it as the following:

a. Press "||" once, the screen display "P100".

b. Press "||" once again or turn "" to choose 80% microwave power.

- c. Press " +30" to confirm, and the screen displays "P 80".
- d. Turn " " to adjust the cooking time till the oven displays "7:00".
- After the aboved steps, be careful not to press " +30" to start cooking.

3) Press " |  ", the hour figures will flash.

4) Turn " " to adjust the hour figures, the input time should be within 0--23.

5) Press " |  ", the minute figures will flash.

6) Turn " " to adjust the minute figures, the input time should be within 0--59.

7) Press " +30" to finish setting. If the door is closed, buzzer will ring twice when the time arrives, then cooking will start automatically.



9. Multi-section cooking





At most 2 sections can be set for cooking. In multi-section cooking, if one section is defrosting, then defrosting shall be placed in the first section.

Example: If you want to defrost food for 5 minutes and then cook with 80% microwave power for 7 minutes, operate it as the following:

1) Press " |  " twice, and the oven will display "dEF2".

2) Turn " " to select the defrost time till "5:00" display.

3) Press " |  |  " once, the screen display "P100".







4) Press " |  |  " once again or turn " " to choose 80% microwave power.

5) Press " +30" to confirm, and the screen displays "P 80".



6) Turn " " to adjust the cooking time till the oven displays "7:00".

7) Press " +30" to start cooking, and buzzer will sound once for the first section, defrosting time counts down; buzzer will sound once again entering the second cooking. when cooking finish, buzzer sounds five times.

10. Inquiring Function

- (1) In states of microwave, grill and combination cooking, press "  |  |  ", the current power will be displayed for 3 seconds. After 3 seconds, the oven will turn back to the former state;
- (2) In cooking state, press "  |  " to inquire the time and the time will display for 3 seconds.
- (3) In preset state, press "  |  " to inquire the preset time, and the preset time will display for 3 seconds.

11. Lock-out Function for Children

Lock: In waiting state, press "  STOP " for 3 seconds, there will be a long beep denoting entering the children-lock state and the current time will display if the time has been set, otherwise, the LED will display "  ".

Lock quitting: In locked state, press "  STOP " for 3 seconds, there will be a long "beep" denoting that the lock is released.

Trouble shooting

If something does trouble shooting; before seeking assistance carry out the following checks first.

Normal	
Microwave oven interfering TV reception	Radio and TV reception may be interfered when microwave oven operating. It is similar to the interference of small electrical appliances, like mixer, vacuum cleaner, and electric fan. It is normal.
Dim oven light	In low power microwave cooking, oven light may become dim. It is normal.
Steam accumulating on door, hot air out of vents	In cooking, steam may come out of food. Most will get out from vents. But some may accumulate on cool place like oven door. It is normal.
Oven started accidentally with no food in.	It is forbidden to run the unit without any food inside. It is very dangerous.

Trouble	Possible Cause	Remedy
Oven can not be started.	(1) Power cord not plugged in tightly.	Unplug. Then plug again after 10 seconds.
	(2) Fuse blowing or circuit breaker works.	Replace fuse or reset circuit breaker (repaired by professional personnel of our company)
	(3) Trouble with outlet.	Test outlet with other electrical appliances.
Oven does not heat.	(4) Door not closed well.	Close door well.
Glass turntable makes noise when microwave oven operates	(5) Dirty roller rest and oven bottom.	Refer to "Maintenance of Microwave" to clean dirty parts.

CUSTOMER ASSISTANCE SERVICE

If you cannot identify the cause of the operating anomaly: switch off the appliance (do not subject it to rough treatment) and contact the Assistance Service.

PRODUCT SERIAL NUMBER. Where can I find it?

It is important that you to inform the Assistance Service of your product code and its serial number (a 16 character code which begins with the number 3); this can be found on the guarantee certificate or on the data plate located on the appliance.

It will help to avoid wasted journeys to technicians, thereby (and most significantly) saving the corresponding callout charges.



This appliance is marked according to the European directive 2002/96/EC on Waste Electrical and Electronic Equipment (WEEE). By ensuring this product is disposed of correctly, you will help prevent potential negative consequences for the environment and human health, which could otherwise be caused by inappropriate waste handling of this product.

The symbol on the product indicates that this product may not be treated as household waste. Instead it shall be handed over to the applicable collection point for the recycling of electrical and electronic equipment. Disposal must be carried out in accordance with local environmental regulations for waste disposal.

For more detailed information about treatment, recovery and recycling of this product, please contact your local city office, your household waste disposal service or the shop where you purchased the product.



Four à micro-ondes
MANUEL D'INSTRUCTIONS
MODELES: MIC 20G DFX
MIC 20G DFN

Avant d'utiliser le four à micro-ondes lire attentivement ces instructions et les conserver précieusement.

Si vous suivez les instructions décrites ci-après, votre four vous garantira un service excellent pendant de longues années.

CONSERVER CES INSTRUCTIONS AVEC SOIN

PRECAUTIONS AFIN D'EVITER D'EVENTUELLES EXPOSITIONS EXCESSIVES A L'ENERGIE DES MICRO-ONDES.

(a) Ne jamais faire fonctionner le four avec la porte ouverte, ceci pourrait provoquer une exposition dangereuse à l'énergie du micro-onde. Important: ne pas forcer ou rompre les fermetures de sécurité.

(b) Ne positionner aucun objet entre la partie antérieure du four et la porte, ne pas laisser s'accumuler des résidus de graisses ou de détergents sur les surfaces des joints d'étanchéité.

(c) ATTENTION: si la porte ou le joint sont endommagés, le four ne doit pas être utilisé tant que n'est pas effectuée la réparation par un personnel compétent.

INDEX

Si l'appareil n'est pas bien nettoyé, la surface externe peut être endommagée et donc réduire la durée de l'appareil ou encore l'exposer à des situations dangereuses.

Spécificités techniques

Modèles	MIC 20G DFX MIC 20G DFN
Tension standard de l'appareil	230V~50Hz
Puissance nominale en entrée (Micro-onde)	1250W
Puissance nominale en sortie (Micro-onde)	800 W
Puissance nominale en entrée (Grill)	1000W
Capacité volumétrique du four	20 L
Diamètre du plat tournant	Ø 245mm
Dimensions externes(LxPxH)	594 x345x 388 mm
Poids net	15 kg

AVERTISSEMENTS IMPORTANTS POUR VOTRE SECURITE ATTENTION

Afin de diminuer le risque d'incendie, court-circuit, dommages aux personnes ou exposition excessive à l'énergie des micro-ondes durant l'utilisation de l'appareil, nous vous conseillons de suivre les précautions de base suivantes:

- 1.Attention: Liquides ou autres aliments ne doivent pas être réchauffés dans des flacons fermés hermétiquement car ils sont susceptibles d'exploser.
- 2.Attention: il est dangereux pour tout personnel non spécialisé de démonter la couverture de protection prévue pour garantir la protection contre l'exposition à l'énergie à micro-ondes.
- 3.Attention: Ne permettez l'utilisation du four à des enfants qu'après leur avoir donné les instructions appropriées pour une correcte utilisation et les avoir mis en garde contre les risques encourus en cas d'une utilisation inappropriée.
- 4.Attention: Quand le four est utilisé en mode combiné, les enfants ne peuvent l'utiliser qu'en présence d'un adulte ceci en raison de la température émise (seulement pour le modèle avec grill)
5. Utilisez seulement des ustensiles appropriés pour l'utilisation du four à micro-ondes.
6. Le four doit être nettoyé régulièrement , tout dépôt d'aliment doit être éliminé.
7. Lire et suivre les données spécifiques "Précautions afin d'éviter d'éventuelles expositions excessives à l'énergie à micro-ondes ".
8. Quand vous réchauffez des aliments en récipients de plastique ou en carton, contrôler le four en raison du risque d'incendie.

9. Si vous constatez la présence de fumée, éteindre ou débrancher la prise de courant et laisser la porte du four fermée afin d'étouffer toutes flammes éventuelles.
10. Ne pas cuire de façon excessive les aliments.
11. Ne jamais utiliser la cavité du four comme récipient. Ne pas laisser des produits comme du pain, des biscuits à l'intérieur du four.
12. Oter les fermetures en métal ou poignées métalliques des récipients de métal ou de carton avant de les mettre dans le four.
13. Installer et positionner le four selon les instructions fournies pour l'installation.
14. Les oeufs durs ou avec leur coquille ne doivent être réchauffés dans le four à micro-ondes parce qu'ils sont susceptibles de provoquer une explosion même une fois la cuisson terminée.
15. Utiliser cet appareil seulement selon l'usage indiqué par le présent manuel d'instructions. Ne jamais utiliser de produits ou vapeurs corrosives dans cet appareil électroménager. Ce four est spécifiquement conçu pour réchauffer. Il n'est pas étudié pour des utilisations industrielles ou en laboratoire.
16. Si le fil d'alimentation fourni est endommagé, il doit être substitué par le fabricant, par son service d'entretien ou par une personne qualifiée ceci afin de prévenir toutes situations dangereuses.
17. Ne jamais stocker ou utiliser cet appareil à l'extérieur.
18. Ne pas utiliser ce four à proximité d'eau, dans un évier humide ou près d'une piscine.
19. La température des surfaces accessibles pourrait être élevée durant le fonctionnement du four. Tenir le fil d'alimentation loin de toute source de chaleur et en aucun cas ne jamais couvrir le four.
20. Ne jamais laisser le fil d'alimentation suspendu sur le bord d'une table ou d'un plan de travail.

21. La non observation des conditions normales d'entretien pourrait endommager les surfaces, causer une réduction de la durée de vie de l'appareil mais aussi provoquer des situations dangereuses.
22. Le contenu de biberons ou les flacons d'aliments pour bébés doivent être mélangés ou agités et la température de ces derniers doit être contrôlée afin d'éviter toutes brûlures.
23. Le réchauffement à micro-ondes de boissons peut provoquer un processus d'ébullition retardée, par conséquent, faire attention quand vous manipulez le flacon.
24. Cet appareil n'est pas destiné à être utilisé par des personnes (y compris les enfants) dont les capacités physiques, sensorielles ou mentales sont réduites, ou ayant un manque d'expérience et de connaissances, à moins qu'elles n'aient été formées à l'utilisation de l'appareil, par une personne responsable de leur sécurité.
25. Les enfants doivent être surveillés pour s'assurer qu'ils ne jouent pas avec l'appareil.
26. Le four micro-onde ne doit pas être placé à l'intérieur des compartiments prévus au stockage de la nourriture, sauf s'ils sont recommandés par le fabricant.
27. L'appareil n'est pas destiné à fonctionner avec un minuteur externe ou un système de contrôle externe.
28. Avertissement: il convient de débrancher l'appareil pour changer l'ampoule afin d'éviter la possibilité d'une électrocution.
29. Les parties accessibles peuvent devenir chaude pendant l'utilisation. Les jeunes enfants doivent être tenu à l'écart.
30. Le tiroir de rangement peut devenir chaud.
31. Ne pas utiliser de produit de nettoyage abrasif et un racloir métallique pour nettoyer la porte verre du micro-onde qui peuvent rayer la surface et briser la verre.
32. Pendant l'utilisation l'appareil devient chaud. Faites attention à éviter de toucher les éléments chauds à l'intérieur du micro-onde.
33. Utilisez seulement la température recommandée pour le four (pour les fours équiper d'une sonde de température).

34. Positionner la partir arrière du micro-onde contre un mur.

35. Cet appareil peut être utilisé par des enfants de l'âge de 8 ans et plus et les personnes à capacités physiques, sensorielles ou mentales réduites ou qui n'ont pas d'expérience et des connaissances en rapport, si elles ont été supervisées et formées sur l'utilisation de cet appareil en toute sécurité et qu'elles ont compris les risques possibles. Les enfants ne doivent pas jouer avec l'appareil. Le nettoyage et l'entretien par l'utilisateur ne doit pas être effectués par les enfants sans surveillance.

36. Gardez l'appareil et son cordon d'alimentation hors de la portée des enfants de moins de 8 ans.

37. En cas de dégagement de fumée, éteignez ou débranchez l'appareil et gardez la porte fermée afin d'étouffer les flammes

38. Cet appareil est conçu pour usages domestiques et d'autres usages analogues tels que:

- les zones de cuisine du personnel dans les magasins, bureaux et autres environnements de travail;
- par les clients dans les hôtels, motels et autres environnements de résidence;
- les fermes;
- les environnements de chambre d'hôte.

39. AVERTISSEMENT: L'appareil et ses accessoires se chauffent pendant le fonctionnement. Il faut veiller à éviter de toucher les pièces chauffantes. Les enfants de moins de 8 ans doivent être tenus à l'écart ou surveillés en permanence.

40. Le four à micro-ondes doit être utilisé avec la porte décorative ouverte. (Pour les fours avec une porte décorative.)

41. Il est interdit d'utiliser le nettoyeur à vapeur.

42. La surface du tiroir de rangement peut être chaude.

43. N'utilisez pas de produits nettoyants abrasifs ou de grattoirs métalliques pour nettoyer la vitre de la porte du four car ils peuvent rayer la surface, ce qui peut briser la vitre.

LISEZ ATTENTIVEMENT ET CONSERVEZ POUR RÉFÉRENCE ULTÉRIEURE

Instructions pour diminuer le risque de dommages aux personnes

Installation de la prise de terre

DANGER

Danger de décharge électrique

Toucher certains composants internes peut provoquer d'importants dommages aux personnes ou la mort. Ne jamais démonter l'appareil.

ATTENTION

Danger de décharge électrique Une utilisation incorrecte de la prise de terre peut provoquer une décharge électrique. Ne pas connecter au réseau électrique tant que l'appareil n'est pas correctement installé avec l'installation d'une prise de terre.

Pour diminuer le risque de dommages aux personnes
Connexion de la mise à terre

NETTOYAGE

S'assurer que le four est débranché du réseau électrique.

1. Après utilisation, nettoyer les surfaces internes du four avec un chiffon légèrement humide.
2. Nettoyer correctement les accessoires avec de l'eau savonneuse.
3. Le cadre de la porte, le joint d'étanchéité et les parties connexes doivent être nettoyés si besoin, avec de l'eau savonneuse. Cet appareil électroménager doit être relié à la prise de terre. En cas de court-circuit électrique, la terre diminue le risque de décharge électrique fournissant une voie de sortie au courant électrique. Cet appareil est fourni avec un fil d'alimentation doté d'un fil de terre et d'une fiche de branchement avec terre. La fiche doit être insérée dans une prise de courant correctement installée et donc dotée

d'une liaison avec la terre. Contactez un électricien qualifié au cas où vous ne comprenez pas correctement les instructions pour la mise à terre ou au cas où vous avez un doute sur l'exactitude de la connexion à la terre de l'appareil . Au cas où il est nécessaire d'utiliser une rallonge, utiliser uniquement une rallonge à trois sorties comprenant une fiche bipolaire avec cannelure pour la mise à terre ainsi que 2 contacts pour la mise à terre. Une fiche bipolaire munie d'un contact pour la terre est appropriée pour la prise du four.

Le fil électrique fourni avec l'appareil est délibérément court afin de diminuer la possibilité de trébucher ou de l'arracher de la prise, risques possibles avec un fil plus long:

- 1) La tension nominale indiquée sur le fil ou sur la rallonge devraient être au moins équivalents à la tension nominale de l'appareil.
- 2) La rallonge doit être un fil à trois sorties avec mise à terre.
- 3) Le fil long doit être mis de façon à ne pas pendre du plan de travail ou de la table, doit être éloigné de la portée des enfants qui pourraient le tirer ou trébucher de façon impromptue.

USTENSILES

ATTENTION

Risque de dommages aux personnes

Il est dangereux d'effectuer, sans une compétence spécifique, des réparations ou opérations d'entretien prévoyant le démontage du couvercle prévu pour garantir la protection à l'exposition de l'énergie à micro-ondes.

Se référer aux instructions du paragraphe "Matériaux qui peuvent être utilisés dans le four à micro-ondes ou qui doivent être évités dans le four à micro-ondes."

Certains ustensiles non métalliques peuvent être non appropriés pour l'utilisation du four à micro-ondes. En cas de doute, il est possible d'essayer l'ustensile en question suivant la procédure suivante.

Test des ustensiles:

1. Remplir un récipient spécial pour micro-ondes avec une tasse d'eau froide (250 ml) et y mettre l'ustensile en question .
2. Cuire à température maximale durant 1 minute.
3. Toucher avec précaution l'ustensile. Si l'ustensile vide est chaud, ne pas l'utiliser pour la cuisson à micro-ondes .
4. **Ne jamais dépasser le temps de cuisson d'une minute.**

Matériaux qui peuvent être utilisés dans le four à micro-ondes

Pellicule en aluminium	Seulement comme protection. De petits morceaux lisses peuvent être utilisés pour couvrir des parties fines de viande ou volaille afin d'éviter une cuisson excessive . Il peut se former un arc si la pellicule est trop près de la paroi du four. La pellicule doit être positionnée à une distance minimum de 1 pouce (2,5 cm) des parois du four.
Récipients en terre cuite	Suivre les instructions du producteur. Le fonds du récipient en terre cuite doit être positionné à au moins 3/16 de pouce (5mm) au dessous du plat tournant. Une utilisation incorrecte pourrait provoquer la rupture du plat tournant.
Assiettes de table	Seulement celles appropriées pour l'utilisation dans un four à micro-ondes. Suivre les instructions du producteur. Ne pas utiliser des plats cassés ou ébréchés.
Flacons en verre	Oter toujours le couvercle. Utiliser seulement pour réchauffer les aliments jusqu'à tant qu'ils soient chauds. Certains récipients en verre ne sont pas résistants à la chaleur et pourraient donc se casser.
Produits en verre	Utiliser seulement des produits en verre résistants à la chaleur et appropriés pour l'utilisation au four. S'assurer qu'ils ne comportent pas des bords en métal. Ne pas utiliser des plats cassés ou ébréchés.
Sachets pour la cuisson au four	Suivre les instructions du producteur. Ne pas fermer avec des fermetures métalliques. Faire des entailles pour laisser s'échapper la vapeur .
Tasses et plats en plastique	Cuire ou réchauffer pour des temps très courts. Ne pas s'éloigner du four durant la cuisson.

Serviettes en papier	Utiliser pour couvrir les aliments pendant le réchauffement afin d'absorber la graisse éventuelle. Utiliser et contrôler seulement pour des temps de cuisson brefs.
Papier sulfurisé	Utiliser comme couverture pour prévenir éclaboussures ou pour couvrir la vapeur .
Plastique	Seulement plastique appropriée pour le four à micro-ondes. Suivre les instructions du producteur. Doit être indiquée "compatible pour micro-ondes". Certains récipients en plastique ramollissent quand les aliments réchauffent. Les sacs et sachets pour la cuisson et sacs en plastique fermés hermétiquement doivent être troués comme indiqué sur l'emballage même
Pellicule transparente	Seulement celle appropriée pour l'utilisation au four à micro-ondes. L'utiliser pour couvrir les aliments durant la cuisson afin de maintenir l'humidité. S'assurer que la pellicule transparente n'entre pas en contact avec les aliments.
Thermomètres	Seuls ceux appropriés pour l'utilisation des fours à micro-ondes (thermomètres pour viandes et gâteaux).
Papier oléagineux	Utiliser pour couvrir les aliments et prévenir les débordements et maintenir l'humidité. .

Matériaux à éviter dans les fours à micro-ondes

Barquettes en aluminium	Peut provoquer la formation d'un arc. Transvaser les aliments dans des plats appropriés pour l'utilisation en fours à micro-ondes.
Récipients pour aliments en carton avec poignée en métal	Peut provoquer la formation d'un arc. Transvaser les aliments dans des plats appropriés pour l'utilisation au four à micro-ondes..
Ustensiles en métal	Le métal protège les aliments de l'énergie à micro-ondes. Le métal peut provoquer la formation d'un arc .
Fermetures en métal	Peut provoquer la formation d'un arc et pourrait causer un incendie à l'intérieur du four.
Sachets en papier	Pourrait provoquer un incendie à l'intérieur du four.
Récipients en polystyrène ou polyuréthane	Les récipients pourraient fondre ou contaminer le liquide contenu lorsqu'ils sont exposés à de hautes températures.
Bois	Le bois sèche quand est utilisé dans les fours à micro-ondes et pourrait casser ou se fendre.

INSTALLER VOTRE FOUR

Noms des composants et des accessoires du four

Extraire le four de l'emballage ainsi que les accessoires qui se trouvent à l'intérieur du four.

Le four est fourni avec les accessoires suivants :

1 Plateau tournant en verre

1 Ensemble anneau rotatif

1 Manuel d'instructions

A) Panneau de commandes

B) Axe du plateau tournant

C) Anneau de support

D) Plat en verre

E) Fenêtre d'observation

F) Porte

G) Système fermeture de sécurité

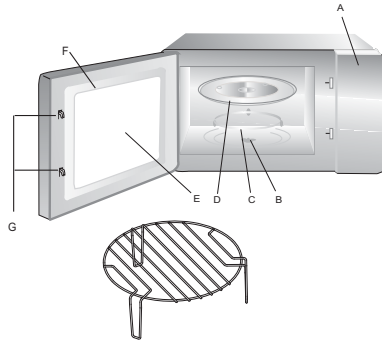

Grill (Seulement pour la version avec grill)

Attention: ne pas utiliser la grille métallique du modèle à micro-ondes. Toujours l'enlever quand on utilise la fonction micro-ondes!

Eteindre le four si la porte reste ouverte durant le fonctionnement.

Installation du plat tournant

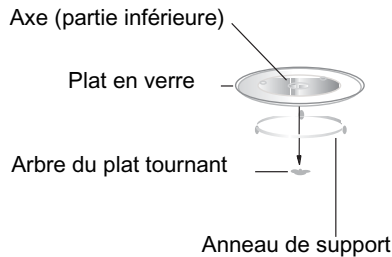

- Ne jamais positionner le plat en verre à l'envers. Le plat en verre ne doit jamais être bloqué.
- Tant le plat en verre que l'anneau de support doivent être toujours être utilisés durant la cuisson .
- Les aliments et récipients doivent toujours être positionnés sur le plat en verre durant la cuisson.
- Si le plat en verre ou l'ensemble anneau de support/plateau tournant devaient se fissurer ou se casser, contacter le centre d'assistance le plus proche.

Installation du plan de travail

Otez de l'emballage le four ainsi que tous les accessoires . Examiner le four afin de vérifier n'est pas endommagé ou que la porte n'est abîmée. Ne pas installer le four s'il est endommagé.

Partie intérieure: Enlever toutes les pellicules de protection présentes sur les surfaces de la partie intérieure du four à micro-ondes.

Ne pas enlever la fine pellicule marron claire collée sur la cavité du four, elle est prévue pour protéger le magnétron.

Installation et branchement

1. Cet appareil est uniquement destiné à l'usage domestique.
2. Ce four est uniquement destiné à être utilisé encastré. Il n'est pas destiné à être utilisé sur un meuble ou à l'intérieur d'un placard.
3. Veuillez respecter les instructions d'installation spécifiques.
4. L'appareil peut être installée dans un placard adossé au mur de 60 cm de large (d'au moins 55 cm de profondeur et à 85cm au-dessus du sol).
5. L'appareil est fourni avec une prise et ne doit être branché qu'à une prise avec terre correctement installée.
6. Le voltage principal doit correspondre au voltage spécifié sur la plaque signalétique.
7. Seul un électricien qualifié peut installer la prise et connecter les câbles. Si la prise n'est plus accessible suite à l'installation, un appareil de déconnexion multipolaire doit être présent du côté de l'installation avec une distance d'isolation d'au moins 3 mm.
8. Ne pas utiliser d'adaptateurs, de multiprises ni de rallonges. Un excès de charge



La surface accessible pourrait être chaude durant le fonctionnement.





Instructions d'utilisation

1. Réglage de l'horloge



Branchez le micro-onde ; l'écran va afficher « 0 :00 » et l'appareil va sonner une fois.

1) Appuyez sur «  |  » , les chiffres de l'heure vont clignoter.

2) Tournez la molette «  » pour changer l'heure, le nombre entré doit être compris entre 0 et 23.

3) Appuyez sur «  |  » , les chiffres des minutes vont clignoter.



4) Tournez la molette «  » pour changer les minutes, le nombre entré doit être compris entre 0 et 59.







5) Appuyez sur «  |  » pour mettre fin au réglage de l'heure. « : » va clignoter et l'heure va s'afficher.

Note : 1) Si l'horloge n'est pas réglée, elle ne fonctionne pas quand le micro-onde est allumé.

2) Si vous appuyez sur «  STOP » pendant le réglage de l'horloge, le four va revenir automatiquement à son état précédent.

2. Cuisson au micro-onde

Appuyez sur «  |  |  » , l'écran va afficher « P100 ». Appuyez plusieurs fois sur

«  |  |  » ou tournez la molette «  » pour choisir la puissance que vous désirez. « P100 », « P80 », « P50 », « P30 » et « P10 » vont s'afficher successivement. Appuyez ensuite sur «  +30'' » pour confirmer et tournez «  » pour régler le temps de cuisson entre 0:05 et 95:00. Appuyez de nouveau sur

«  +30'' » pour lancer la cuisson.

Exemple : Si vous voulez utiliser 80% de la puissance du micro-onde pendant 20 minutes, vous pouvez suivre les étapes suivantes :

1) Appuyez une fois sur «  |  |  » , l'écran va afficher « P100 ».

2) Appuyez une nouvelle fois sur «  |  |  » ou tournez la molette «  » pour choisir 80% de la puissance du micro-onde.



3) Appuyez sur «  +30'' » pour confirmer ; l'écran affiche « P 80 ».

4) Tournez la molette «  » pour régler le temps de cuisson jusqu'à voir s'afficher « 20:00 ».

5) Appuyez sur «  +30'' » pour lancer la cuisson.



Note : Voici les indications pour régler le temps avec la molette :

0---1 min	: 5 secondes
1---5 min	: 10 secondes
5---10 min	: 30 secondes
10---30 min	: 1 minute
30---95 min	: 5 minutes



Ordre «    »	Affichage à l'écran	Puissance du micro-onde	Puissance du grill
1	P100	100%	
2	P80	80%	
3	P50	50%	
4	P30	30%	
5	P10	10%	
6	G	0%	100%
7	C-1	55%	45%
8	C-2	36%	64%

3. Cuisson au grill ou combinée

Appuyez une fois sur «    » ; « P100 » s'affiche. Puis appuyez sur





«    » plusieurs fois ou tournez la molette «  » pour choisir la puissance. « G », « C-1 » ou « C-

2 » vont successivement s'afficher. Appuyez ensuite sur «  +30'' » pour confirmer et tournez la molette

«  » pour régler le temps de cuisson entre 0:05 et 95:00. Appuyez de nouveau sur «  +30'' » pour lancer la cuisson.

Exemple : Si vous voulez utiliser 55% de la puissance du micro-onde et 45% de la puissance du grill (C-1) pour cuire 10 minutes, vous pouvez suivre les étapes suivantes :

1) Appuyez une fois sur «    », l'écran va afficher « P100 ».

2) Appuyez plusieurs fois sur «    » ou tournez la molette «  » pour choisir le mode Combi 1.

3) Appuyez sur «  +30'' » pour confirmer ; l'écran affiche « C-1 ».





4) Tournez la molette «  » pour régler le temps de cuisson jusqu'à voir s'afficher « 10:00 ».

5) Appuyez sur «  +30'' » pour lancer la cuisson.



Note : A la moitié du temps de cuisson du grill, le four sonne normalement deux fois.

Pour que le grill soit plus efficace, vous pouvez alors retourner l'aliment, refermer la porte puis le four continuera la cuisson sans autre manipulation.

4. Démarrage rapide

- 1) Depuis le mode de veille, appuyez sur «  +30'' » pour commencer la cuisson à une puissance de 100%, chaque pression supplémentaire sur le bouton augmente le temps de cuisson de 30 secondes jusqu'à 95 minutes.
- 2) En mode de décongélation ou cuisson par micro-onde, grill ou combi, chaque pression sur «  +30'' » augmente le temps de cuisson de 30 secondes.
- 3) Depuis l' mode de veille, tournez la molette «  » dans le sens inverse des aiguilles d'une montre pour régler le temps de cuisson à 100% de puissance, puis appuyez sur «  +30'' » pour lancer la cuisson.



5. Décongélation en fonction du poids

- 1) Appuyez une fois sur «  |  », le four va afficher « dEF1 ».

- 2) Tournez la molette «  » pour choisir le poids de l'aliment, entre 100 et 2000 g.

- 3) Appuyez sur «  +30'' » pour lancer la décongélation.

6. Décongélation en fonction du temps

- 1) Appuyez deux fois sur «  |  », le four va afficher « dEF2 ».

- 2) Tournez la molette «  » pour régler le temps de décongélation.

- 3) Appuyez sur «  +30'' » pour lancer la décongélation.

7. Menu automatique

- 1) Tournez la molette «  » vers la droite pour naviguer dans le menu ; l'écran va afficher « A-1 » à « A-10 », ce qui désigne respectivement pizza, Batatas, Carne, Peixe, Verduras, Boisson, Massas, Popcorn, Poulet, Rechauffage

 - 2) Appuyez sur «  +30'' » pour confirmer.

 - 3) Tournez la molette «  » pour choisir le poids par défaut comme indiqué dans le tableau du menu.

 - 4) Appuyez sur «  +30'' » pour lancer la cuisson.
- Exemple : Si vous voulez utiliser le menu automatique pour cuire 350g de poisson :

- 1) Tournez la molette «  » dans le sens des aiguilles d'une montre jusqu'à ce que « A-4 » s'affiche.

- 2) Appuyez sur «  +30'' » pour confirmer.

3) Tournez la molette «  » pour régler le poids du poisson jusqu'à voir s'afficher « 350 ».

4) Appuyez sur «  +30'' » pour lancer la cuisson.

Tableau du menu :

Menu	Oeso	Visor
A-1 Pizza	200 g	200 g
	400 g	400 g
A-2 Batatas	200 g	200 g
	400 g	400 g
	600 g	600 g
A-3 Carne	250 g	250 g
	350 g	350 g
	450 g	450 g
A-4 Peixe	250 g	250 g
	350 g	350 g
	450 g	450 g
A-5 Verduras	200 g	200 g
	300 g	300 g
	400 g	400 g
A-6 Boisson	1 (120ml)	1
	2 (240ml)	2
	3 (360ml)	3
A-7 Massas	50g (com 450 de água fria)	50 g
	100g (com 800 de água fria)	100 g
A-8 Popcorn	50 g	50 g
	100 g	100 g
A-9 Poulet	200 g	200 g
	400 g	400 g
	600 g	600 g
	800 g	800 g
A-10 Rechauffage	200 g	200 g
	400 g	400 g
	600 g	600 g

8. Préréglage

1) Commencez par régler l'horloge. (Consultez les instructions pour le réglage de l'horloge.)

2) Saisissez le programme de cuisson. Il est possible de programmer deux étapes au maximum. La décongélation ne doit pas être définie comme programme de cuisson.

Exemple : Si vous voulez cuire à 80% de la puissance du micro-onde pendant 7 minutes, vous pouvez suivre ces instructions :



a. Appuyez une fois sur «  », l'écran affiche « P100 ».

b. Appuyez de nouveau sur «  » ou tournez la molette «  » pour régler la puissance du micro-onde à 80%.



c. Appuyez sur «  +30" » pour confirmer, l'écran affiche « P 80 ».

d. Tournez la molette «  » pour régler le temps de cuisson jusqu'à ce que le four affiche « 7 :00 ».

Suite aux étapes précédentes, faites attention de ne pas appuyer sur «  +30" » pour ne pas lancer la cuisson.

3) Appuyez sur «  |  » , les chiffres de l'heure vont clignoter.

4) Tournez la molette  pour régler l'heure, le nombre entré doit être compris entre 0 et 23.

5) Appuyez sur «  |  » , les chiffres des minutes vont clignoter.



6) Tournez la molette  pour régler les minutes, le nombre entré doit être compris entre 0 et 59.

7) Appuyez sur "  +30" " pour mettre fin au réglage. Si la porte est fermée, le four sonne deux fois quand l'heure programmée arrive, puis la cuisson commence automatiquement.

9. Cuissons successives





On peut définir un maximum de 2 parties pour la cuisson. En cuisson successive, si l'une des parties est la décongélation, alors la décongélation doit être placée en premier.

Exemple : Si vous voulez décongeler un aliment pendant 5 minutes puis le cuire à 80% de la puissance du micro-onde pendant 7 minutes, vous pouvez suivre ces instructions :

1) Appuyez deux fois sur «  |  » ; le four affiche « dEF2 ».

2) Tournez la molette «  » pour régler le temps de décongélation jusqu'à voir s'afficher « 5:00 ».

3) Appuyez une fois sur «  |  |  » , l'écran affiche « P100 ».



4) Appuyez de nouveau sur «  |  |  » ou tournez la molette «  » pour régler la puissance du micro-onde à 80%.



5) Appuyez sur «  +30" » pour confirmer ; l'écran affiche « P 80 ».



6) Tournez la molette «  » pour régler le temps de cuisson jusqu'à voir s'afficher « 7:00 ».

7) Appuyez sur «  +30" » pour lancer la cuisson ; le four va sonner une fois pour la première partie, le temps de décongélation se décompte. Puis le four va sonner une nouvelle fois au début de la deuxième cuisson. Quand la cuisson se termine, le four sonne cinq fois.



10. Fonction interrogation

1) Dans les modes de cuisson par micro-ondes, grill et combinée, appuyez sur «  |  |  », la puissance actuelle sera affichée pendant 3 secondes. Après 3 secondes, le four va revenir à son état précédent.

2) Pendant la cuisson, appuyez sur «  |  » pour interroger l'horloge et l'heure va s'afficher pendant 3 secondes.

3) En mode pré-réglé, appuyez sur «  |  » pour interroger le temps de pré-réglage et il s'affichera pendant 3 secondes.

11. Fonction de sécurité enfants

Verrou : En mode veille, appuyez sur «  STOP » pendant 3 secondes ; vous allez entendre un long bip indiquant le passage à l'état de sécurité enfants et l'indicateur de sécurité va s'afficher si l'horloge a été réglée ; sans quoi l'écran affichera «  ».

Déverrouiller : En état verrouillé, appuyez sur «  STOP » pendant 3 secondes. Vous entendrez un long bip indiquant que la sécurité est désactivée.

Recherche des problèmes

Si vous avez besoin d'un dépannage, avant de contacter l'assistance, essayez de vérifier les choses suivantes.

NORMALE	
Interférence du four à micro-ondes sur la réception de la télévision	Peuvent intervenir des interférences avec la réception de radio ou télévision durant le fonctionnement du four à micro-ondes. Il s'agit d'un phénomène courant avec d'autres appareils électroménagers, tels que aspirateurs, ventilateurs électriques. Il s'agit de phénomène normal.
Faible éclairage	Durant la cuisson à micro-ondes à basse pression, la lumière du four peut diminuer. Il s'agit d'un phénomène normal.
De la vapeur s'accumule sur la porte, de l'air chaud sort des orifices d'aération	Durant la cuisson, la vapeur peut s'échapper des aliments. Une bonne partie de cette vapeur est évacuée par les orifices d'aération. Le reste de la vapeur peut s'accumuler sur les surfaces froides, telles la porte du four. Ceci est normal.
Le four est accidentellement allumé sans présence d'aliments à l'intérieur	Le fonctionnement du four pendant de brèves périodes sans présence d'aliments à l'intérieur n'endommage pas le four. Cette situation doit être évitée le plus possible.

Problème	Cause possible	Solution
Le four ne s'allume pas	Le fil d'alimentation n'est pas correctement inséré dans la prise de courant	Débrancher la fiche de la prise, rebrancher après 10 secondes
	Le fusible saute ou entre en fonction l'interrupteur automatique	Substituer le fusible ou réparer l'interrupteur automatique (la réparation doit être effectuée par du personnel qualifié)
	Problèmes en sortie	Vérifier la sortie avec un autre appareil électroménager
Le four ne réchauffe pas	La porte n'est correctement fermée	Bien fermer la porte
Le plat en verre fait du bruit pendant le fonctionnement du four	Les roulements sont sales et présence de résidus sur le fond du four	Se référer au paragraphe "entretien du micro-ondes" pour nettoyer les surfaces sales.

SERVICE D'ASSISTANCE CLIENT Si vous ne pouvez pas identifier la cause de l'anomalie de fonctionnement : éteignez l'appareil (ne lui faites pas subir de mauvais traitement) et contactez le service d'assistance. **NUMERO DE SERIE DU PRODUIT** Où puis-je le trouver ? Il est important que vous fournissiez au service d'assistance le code et le numéro de série (un numéro à 16 chiffres qui commence par le numéro 3) de votre produit. Vous pouvez le trouver sur le certificat de garantie ou sur la place signalétique située sur l'appareil. Cela aidera les techniciens à éviter des déplacements pour rien, permettant ainsi (et surtout) d'économiser les frais d'intervention correspondants.



Cet appareil est en conformité avec la directive européenne 2002/96/EC relative aux déchets d'équipements électriques et électroniques (WEEE). En vous assurant que ce produit est détruit correctement, vous aidez à empêcher des conséquences négatives potentielles pour l'environnement et la santé humaine, que pourraient dans le cas contraire causer une gestion des déchets inappropriée à ce produit. Le symbole sur le produit indique qu'il ne peut pas être traité comme déchet domestique. Au

contraire il devrait être apporté au point de ramassage le plus proche pour le recyclage des équipements électrique et électronique. L'élimination doit se faire conformément aux réglementations locales pour la gestion des ordures. Pour plus d'informations sur le traitement, la récupération et le recyclage de ce produit, merci de contacter votre administration locale, le service de ramassage des déchets de votre habitation ou le magasin où vous avez acheté ce produit.



Forno a microonde
MANUALE DI ISTRUZIONI
MODELES: MIC 20G DFX
MIC 20G DFN

Leggere attentamente queste istruzioni prima dell'utilizzo del forno a microonde e conservarle con cura.

Se seguirete le istruzioni qui contenute, il vostro forno vi garantirà un servizio eccellente per molti anni.

CONSERVARE QUESTE ISTRUZIONI CON CURA

PRECAUZIONI PER EVITARE LA POSSIBILE ESPOSIZIONE A UN'ENERGIA ECCESSIVA DEL MICROONDE

(a) Non utilizzare il forno a microonde quando lo sportello è aperto perché ciò potrebbe comportare il rischio di esposizione all'energia prodotta dal forno stesso, con il conseguente rischio di danni per la salute. Non rompere o manomettere gli interblocchi di sicurezza.

(b) Non collocare alcun oggetto tra il lato anteriore del forno e lo sportello e rimuovere sempre tutto lo sporco e i residui di soluzioni detergenti dalle superfici di tenuta.

(c) **AVVERTENZA:** se lo sportello è aperto o le tenute sono danneggiate, non utilizzare il forno a microonde e farlo riparare da una persona competente.

AGGIUNTA

La mancata pulizia del forno a microonde potrebbe deteriorare le sue superfici, ridurre la vita utile del forno stesso e dar luogo a situazioni pericolose.

Specifiche tecniche

Modelli	MIC 20G DFX MIC 20G DFN
Tensione nominale	230V~50Hz
Potenza nominale in ingresso (Microonde)	1250 W
Potenza nominale in uscita (Microonde)	800 W
Potenza nominale in ingresso (Grill)	1000 W
Capacità del forno	20 L
Diametro del piatto rotante	∅ 245 mm
Dimensioni esterne(LxPxH)	594 x 345 x 388 mm
Peso netto	15 kg

ISTRUZIONI IMPORTANTI PER LA SICUREZZA

AVVERTENZA

Per limitare il rischio di scosse elettriche, lesioni personali o di un'esposizione a un'energia eccessiva del microonde, attenersi alle seguenti precauzioni di base durante l'uso del forno:

1. Avvertenza: non riscaldare liquidi e altri alimenti in contenitori chiusi poiché potrebbero esplodere.
2. Avvertenza: la copertura che protegge dall'esposizione all'energia prodotta dal forno a microonde deve essere rimossa solo da persone competenti.
3. Avvertenza: non permettere ai bambini di usare il forno senza la supervisione di un adulto se non sono state fornite loro istruzioni adeguate in modo che sappiano come usarlo in modo sicuro e siano consapevoli dei possibili rischi risultanti da un uso improprio.
4. Avvertenza: in modalità Combi, l'uso del forno è consentito ai bambini solo sotto la supervisione di un adulto a causa delle temperature alte prodotte in questa modalità (solo per i modelli muniti di grill).
5. Utilizzare solo utensili compatibili con i forni a microonde.
6. Pulire regolarmente il forno e rimuovere tutti i depositi di cibo.
7. Leggere e attenersi a quanto indicato nella sezione "PRECAUZIONI PER EVITARE LA POSSIBILE ESPOSIZIONE A UN'ECESSIVA ENERGIA DEL MICROONDE".
8. Durante il riscaldamento di alimenti contenuti in vaschette in plastica o carta, controllare il forno perché è possibile che i contenitori si incendino.

9. Se si nota la presenza di fumo, spegnere il forno o scollegarlo dall'alimentazione elettrica e chiudere lo sportello per impedire alle fiamme di propagarsi.
10. Non riscaldare eccessivamente gli alimenti.
11. Non utilizzare la cavità per conservare gli alimenti. Non conservare alimenti come pane, biscotti, ecc., all'interno del forno.
12. Rimuovere sempre i laccetti di chiusura e le impugnature in metallo dai sacchetti in carta o plastica prima di inserirli nel forno.
13. Installare e posizionare il forno solo in conformità a quanto indicato nelle istruzioni di installazione.
14. Non riscaldare uova racchiuse nel guscio o bollite per lunghi periodi di tempo nel microonde poiché potrebbero esplodere anche dopo il termine della cottura.
15. Utilizzare il forno solo per l'uso previsto e in conformità a quanto indicato in questo manuale. Non usare sostanze chimiche o vapori che potrebbero corrodere il forno. Questo forno è espressamente progettato per il riscaldamento di alimenti. Non è indicato per essere usato per applicazioni industriali o di laboratorio.
16. Se il cavo di alimentazione è danneggiato, deve essere sostituito dal costruttore, da un rappresentante o da una persona con analogha qualifica per evitare danni.
17. Non conservare o utilizzare il forno in ambienti aperti.
18. Non utilizzare il forno in presenza di acqua, in cantine umide o vicino a piscine.
19. La temperatura delle superfici esterne potrebbe raggiungere valori molto alti quando il forno è in uso. Le superfici si riscaldano durante l'uso. Tenere il cavo di alimentazione lontano dalle superfici calde e non coprire nessuna delle aperture di ventilazione.

20. Non lasciare pendere il cavo di alimentazione dal bordo di un tavolo o banco.
21. La mancata pulizia regolare del forno potrebbe deteriorare le superfici, ridurre la vita utile del forno e causare situazioni pericolose.
22. Per evitare possibili ustioni, mescolare e agitare il contenuto di biberon e barattoli contenenti alimenti per neonati.
23. Il riscaldamento di bibite con il forno a microonde potrebbe provocare un'ebollizione ritardata. Manipolare il contenitore con estrema cautela.
24. Questo apparecchio non deve essere utilizzata da persone (bambini inclusi) con ridotte capacità fisiche, sensoriali o mentali o senza esperienza e sufficiente conoscenza del suo utilizzo, a meno che ciò avvenga sotto la supervisione di una persona responsabile della loro sicurezza o siano state date istruzioni relative al suo utilizzo.
25. Verificare sempre che i bambini non giochino con la piastra.
26. Le unità non sono progettate per essere comandate mediante l'utilizzo di un timer esterno o un telecomando dedicato.
27. **AVVERTENZA:** per evitare possibili scosse elettriche, verificare che l'unità sia spenta prima di sostituire la lampadina.
28. Le parti accessibili potrebbe riscaldarsi durante l'uso. Evitare che i bambini possano avvicinarsi. Non utilizzare sistemi di pulizia a vapore.
29. Non utilizzare detergenti aggressivi o raschietti in metallo appuntiti per pulire il vetro dello sportello perché potrebbero graffiare le superfici e scheggiare il vetro.
30. Il forno si riscalda durante l'uso. Fare attenzione a non toccare le resistenze all'interno del forno.

31. Utilizzare solo la sonda di temperatura consigliata per questo forno (per i modelli muniti di sonda di rilevamento della temperatura).

32. Posizionare la superficie posteriore contro il muro.

33. Questo apparecchio può essere utilizzato da bambini di età superiore agli 8 anni, da persone con ridotte capacità sensoriali o mentali o con poca esperienza che siano stati istruiti in merito all'uso dell'apparecchio in sicurezza e che siano consapevoli dei relativi rischi. I bambini non devono giocare con l'apparecchio né eseguire operazioni di pulizia e manutenzione senza la supervisione di un adulto.

34. Tenere l'apparecchio e il cavo fuori dalla portata di bambini al di sotto degli 8 anni.

35. In caso di emissione di fumo, disattivare o scollegare l'apparecchio e tenere la porta chiusa al fine di fermare eventuali fiamme

36. L'apparecchio è destinato all'uso domestico e trova le seguenti applicazioni:

- personale di cucina all'interno di negozi, uffici e altri ambienti lavorativi;
- clienti di hotel, motel e altri ambienti abitativi;
- Agriturismi;
- bed and breakfast.

37. **ATTENZIONE:** l'apparecchio e le sue parti visibili si surriscaldano durante l'uso. Evitare accuratamente di toccare gli elementi incandescenti. Evitare l'uso da parte di bambini al di sotto degli 8 anni se non sotto la supervisione continua da parte di un adulto.

38. durante l'uso del forno a microonde lo sportello decorativo deve restare aperto (per modelli con uno sportello decorativo.)

39. Non pulire con l'uso del vapore.

40. la superficie di un cassetto può surriscaldarsi.

41. Non usare detergenti abrasivi acidi o spugnette abrasive di metallo per pulire lo sportello di vetro del forno poiché possono scheggiare la superficie e portare alla frantumazione del vetro.

LEGGERE ATTENTAMENTE E CONSERVARE

Per ridurre il rischio di lesioni alle persone Collegamento del forno a microonde a terra

PERICOLO

Pericolo di scariche elettriche
Il contatto con alcuni componenti interni può causare lesioni personali gravi o la morte. Non smontare l'unità.

AVVERTENZA

Rischio di scosse elettriche
Un uso improprio del collegamento di terra può causare scosse elettriche. Collegare l'unità alla presa elettrica solo dopo che è stata installata e correttamente collegata a terra.

PULIZIA

Scollegare sempre l'unità dall'alimentazione elettrica.

1. Pulire l'interno del forno a microonde dopo l'uso con un panno leggermente inumidito.
2. Pulire gli accessori seguendo la normale procedura e utilizzando acqua e sapone.

3. Pulire a fondo il telaio dello sportello e i componenti vicini con un panno inumidito se sporchi.

L'unità deve essere dotata di messa a terra. In caso di cortocircuito, la messa a terra limita il rischio di scosse elettriche poiché fornisce un percorso per la dissipazione della corrente elettrica. Questo forno viene fornito con un cavo dotato di un filo e una spina di messa a terra. Deve essere collegato a una presa a muro correttamente installata e dotata di idonea messa a terra. Rivolgersi a un elettricista o a un tecnico qualificato se le istruzioni per la messa a terra non sono chiare o se si sospetta che l'unità non sia stata correttamente collegata a terra. Se si rende necessario utilizzare un cavo di prolunga, utilizzare solo con un cavo con 3 fili.

1. Insieme all'unità viene fornito solo un cavo di alimentazione corto per limitare al minimo il rischio di rimanere intrappolati o di inciampare.
2. Nel caso si utilizzi un cavo di alimentazione lungo o un cavo di prolunga:
 - 1) Verificare che le caratteristiche elettriche del set di cavi o del cavo di prolunga corrispondano o siano superiori a quelle dell'unità.
 - 2) Verificare che il cavo di prolunga sia un cavo di messa a terra con 3 fili.
 - 3) Disporre il cavo lungo in modo che non penda dal bancone o dal tavolo e possa quindi essere tirato da bambini o sia accidentalmente di intralcio.

UTENSILI

ATTENZIONE

Rischio di lesioni per il personale

E' da considerarsi pericoloso per chiunque non abbia una specifica competenza effettuare riparazioni o manutenzioni che prevedano la rimozione di un coperchio che garantisca una protezione dall'esposizione all'energia a microonde.

Fare riferimento alle istruzioni al paragrafo "Materiali che possono essere utilizzati nel forno a microonde o che devono essere evitati nel forno a microonde."

Potrebbero esserci utensili non metallici non idonei per utilizzo nel forno a microonde. In caso di dubbio, è possibile provare l'utensile in questione seguendo la seguente procedura.

Test degli utensili:

1. Riempire un contenitore idoneo per utilizzo nel forno a microonde con una tazza di acqua fredda (250 ml) e con l'utensile in questione.
2. Cuocere alla massima temperature per 1 minuto.
3. Cautamente toccare l'utensile. Se l'utensile vuoto è caldo, non utilizzatelo per cotture a microonde.
4. **Non superare il tempo di cottura di 1 minuto.**

Materiali che possono essere utilizzati nel forno a microonde

Pellicola di alluminio	Solo per protezione. Piccoli pezzi lisci possono essere utilizzati per coprire parti sottili di carne o pollame per prevenire una cottura eccessiva. E' possibile che si verifichi la formazione di arco se la pellicola è troppo vicina alle pareti del forno. La pellicola dovrebbe essere posizionata ad una distanza minima di 1 pollice (2,5 cm) dalle pareti del forno.
Contenitori in terracotta	Seguire le istruzioni del produttore. Il fondo di un contenitore in terracotta deve essere posizionato almeno 3/16 di pollice (5mm) sopra il piatto rotante. Un utilizzo non corretto potrebbe causare la rottura del piatto rotante.
Piatti da tavola	Solo quelli idonei per utilizzo in forni a microonde. Seguire le istruzioni del produttore. Non utilizzare piatti rotti o sbeccati.
Vasi in vetro	Rimuovere sempre il coperchio. Utilizzare solo per scaldare il cibo solo sino a quando sarà caldo. Molti vasi in vetro non sono resistenti al calore e potrebbero rompersi.
Prodotti in vetro	Utilizzare solo prodotti in vetro resistenti al calore e idonei per utilizzo in forno, Assicuratevi che non vi siano bordi in metallo. Non utilizzare piatti rotti o sbeccati.
Borse per cottura in forno	Seguire le istruzioni del produttore. Non chiudere con chiusure metalliche. Praticare dei tagli per consentire la fuoriuscita di vapore.
Tazze e piatti di carta	Utilizzare per brevi periodi unicamente per cuocere/scaldare. Non lasciare il forno incustodito durante la cottura.

Tovaglioli di carta	Utilizzare per coprire il cibo durante il riscaldamento per assorbire eventuale grasso. Utilizzare, controllando, solo per cotture brevi.
Carta uso pergamena	Utilizzare come copertura per prevenire schizzi o come copertura per il vapore.
Plastica	Solo quella idonea per utilizzo in forni a microonde. Seguire le istruzioni del produttore. Dovrebbe essere marcata "Idonea per microonde". Alcuni contenitori in plastica si ammorbidiscono quando il cibo in essi contenuto si scalda. Sacchetti per la cottura e borse in plastica chiuse ermeticamente dovrebbero essere tagliate o forate come indicato sull'imballo stesso.
Pellicola in plastica	Solo quella idonea a utilizzo in forni a microonde. Utilizzare per coprire il cibo durante la cottura per mantenere l'umidità. Assicurarsi che la pellicola in plastica non entri in contatto con il cibo.
Termometri	Solo quelli idonei per utilizzo con forni a microonde (termometri per carne e per dolci).
Carta oleata	Utilizzare per coprire il cibo per prevenire schizzi e mantenere l'umidità.

Materiali da evitare nei forni a microonde

Vassoi in alluminio	Può causare la formazione di arco. Trasferire il cibo in piatti idonei per utilizzo in forni a microonde.
Contenitori per alimenti in cartone con maniglie in metallo	Può causare la formazione di arco. Trasferire il cibo in piatti idonei per utilizzo in forni a microonde.
Utensili in metallo o	Il metallo protegge il cibo dall'energia a microonde. Il metallo può causare la formazione di arco.
Chiusure in metallo	Può causare la formazione di arco e potrebbe causare un incendio all'interno del forno.
Sacchetti di carta	Potrebbe causare un incendio all'interno del forno.
Contenitori in polistirene o poliuretano	I contenitori potrebbero sciogliersi o contaminare il liquido interno quando esposti ad alte temperature.
Legno	Il legno si asciuga quando utilizzato in forni a microonde e potrebbe dividersi o rompersi.

INSTALLARE IL VOSTRO FORNO

Nomi dei componenti e degli accessori del forno

Estrarre il forno e tutti i materiali dall'imballo e dalla cavità del forno.

Il forno è fornito con i seguenti accessori:

- 1 Piatto girevole in vetro
- 1 Insieme anello rotante
- 1 Manuale di istruzioni

- A) Pannello di controllo
- B) Albero del piatto rotante
- C) Anello di supporto
- D) Piatto in vetro
- E) Finestra di osservazione
- F) Porta
- G) Sistema di bloccaggio di sicurezza

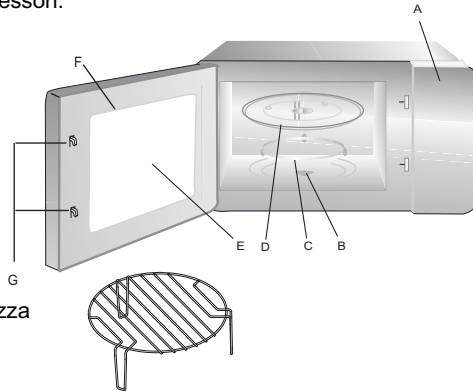

Grill (Solo per la serie con Grill)

Attenzione: non utilizzare la griglia metallica nel modello a microonde. Rimuoverla sempre quando si utilizza la funzione microonde!

Spegnere il forno se la porta rimane aperta durante il funzionamento.

Installazione del piatto rotante

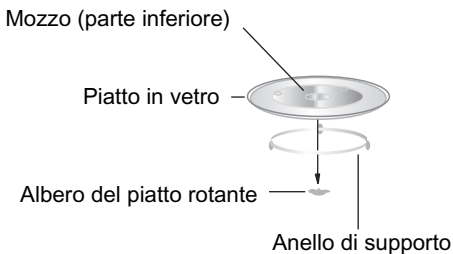

- a. Non posizionate mai il piatto in vetro al contrario. Il piatto in vetro non dovrebbe mai essere vincolato.
- b. Sia il piatto in vetro, sia l'anello di supporto devono sempre essere utilizzati durante la cottura.
- c. Il cibo e i contenitori devono sempre essere posizionati sul piatto in vetro per la cottura.
- d. Se il piatto in vetro o l'insieme anello piatto rotante dovessero incrinarsi o rompersi, contattate il centro di assistenza più vicino.

Installazione del piano di lavoro

Rimuovere tutto il materiale di imballo e gli accessori. Esaminare il forno per verificare che non vi siano danni quali ammaccature o danni alla porta. Non installare il forno se danneggiato.

Parte interna: Rimuovere tutte le pellicole protettive presenti sulle superfici della parte interna del forno a microonde.

Non rimuovere il sottile rivestimento marrone chiaro attaccato alla cavità del forno per proteggere il magnetron.

Informazioni importanti per l'installazione

1. Questo elettrodomestico è destinato al solo uso domestico.
2. Questo forno è da incasso e può essere installato solo come tale. Non può essere usato sistemato su un ripiano o dentro un mobile non idoneo.
3. Seguire le istruzioni specifiche per l'installazione.
4. L'elettrodomestico può essere installato in un mobile installato a muro largo 60 cm (profondità minima: 55cm; altezza minima: 85 cm).
5. Il forno è munito di spina e deve essere collegato solo ad una presa adeguatamente installata e collegata a terra.
6. La tensione di alimentazione deve corrispondere alla tensione indicata sulla targhetta delle specifiche.
7. Solo un elettricista qualificato può installare la presa e sostituire il cavo di collegamento. Se dopo aver incassato il prodotto la spina non è più accessibile, sul lato dell'installazione deve essere presente un interruttore isolante onnipolare con una distanza fra i contatti di almeno 3mm.
8. Non utilizzare adattatori, prese a più uscite e prolunghe. Un eventuale sovraccarico può provocare rischio di incendio.



La superficie accessibile potrebbe essere calda nel corso del funzionamento.





Istruzioni di funzionamento

1. Impostazione dell'orario



Non appena il forno a microonde viene collegato alla presa di rete, sul display viene visualizzato "0:00" e viene emesso un segnale acustico.

- 1) Premere "  |  " ; le cifre che indicano l'ora lampeggiano.

- 2) Ruotare "  " per regolare l'ora, scegliendo un numero compreso tra 0 e 23.

- 3) Premere "  |  " ; le cifre che indicano i minuti lampeggiano.







- 4) Ruotare "  " per regolare i minuti, scegliendo un numero compreso tra 0 e 59.

- 5) Premere "  |  " per completare l'impostazione dell'orario. ":" lampeggia e l'orario impostato si illumina.

Nota:

- 1) Anche se è collegato alla presa di corrente, il forno non funziona se l'orologio non è impostato.
- 2) Se durante la procedura di impostazione dell'orario si preme "  STOP ", il forno ripristinerà automaticamente l'impostazione precedente.



2. Cottura a microonde





Premere "  |  |  " ; sul display viene visualizzato "P100". Premere "  |  |  " più

volte oppure ruotare "  " per scegliere la potenza desiderata; ad ogni pressione del tasto, verranno visualizzate in successione le indicazioni "P100", "P80", "P50", "P30" o "P10". Premere "  +30" " per confermare, quindi ruotare "  "

per impostare un tempo di cottura compreso tra 0:05 a 95:00. Premere "  +30" " di nuovo per avviare la cottura.

Esempio: Se si vuole cuocere con una potenza dell'80% per 20 minuti, impostare il forno secondo le seguenti istruzioni.

- 1) Premere una volta "  |  |  " , il display visualizzerà "P100".

- 2) Premere di nuovo "  |  |  " una volta o ruotare "  " per selezionare la potenza dell'80%.

- 3) Premere "  +30" " per confermare, il display visualizzerà "P80".

- 4) Ruotare "  " per regolare il tempo di cottura finché il display del forno non visualizzerà "20:00".



- 5) Premere "  +30" " per avviare la cottura.





Nota: il selettore consente di aumentare o diminuire il tempo di cottura secondo i seguenti incrementi:

0---1 min	: 5 secondi
1---5 min	: 10 secondi
5---10 min	: 30 secondi
10---30 min	: 1 minuto
30---95 min	: 5 minuti



Ordine	Visualizzazione codici comando	Potenza microonde	Potenza Grill
1	P100	100%	
2	P80	80%	
3	P50	50%	
4	P30	30%	
5	P10	10%	
6	G	0%	100%
7	C-1	55%	45%
8	C-2	36%	64%

3. Cottura grill o combinata.

Premere    " una volta e verrà visualizzato "P100"; premere quindi più volte





   " o ruotare  fino a selezionare la potenza desiderata. Ad ogni pressione del tasto verranno

visualizzate in sequenza le sigle "G", "C-1" o "C-2". Premere  "+30'' " per confermare, quindi ruotare

 " per impostare un tempo di cottura compreso tra 0:05 e 95:00. Premere  "+30'' " di nuovo per avviare la cottura.

Esempio: se si vuole cuocere per 10 minuti con la potenza del microonde del 55% e la potenza del grill del 45%, seguire le seguenti istruzioni.

1) Premere una volta    "; il display viene visualizzato "P100".

2) Premere    " alcune volte oppure ruotare  fino a selezionare la modalità Combi 1.

3) Premere  "+30'' " per confermare; sul display viene visualizzato "C-1".

4) Ruotare  " per regolare il tempo di cottura finché sul display del forno non verrà visualizzato "10:00".

5) Premere  "+30'' " per avviare la cottura.



Nota: nella modalità grill, una volta trascorsa la metà del tempo impostato, il forno emette due segnali acustici; questa procedura è normale.

Per ottenere un risultato ottimale, dopo i due segnali acustici girare il cibo e chiudere lo sportello; se non vengono eseguite altre operazioni, il forno riprenderà a cuocere.

4. Avvio veloce

- 1) In modalità di attesa, premere "  +30" " per avviare la cottura con una potenza del 100%; ad ogni pressione del tasto si aggiungono 30 secondi al tempo di cottura, per un massimo di 95 minuti.
- 2) Nelle modalità microonde, grill, combi o scongelamento con impostazione del tempo, ogni pressione sul tasto

"  +30" " aumenta di 30 secondi il tempo di cottura.

- 3) In pausa modalità di attesa, ruotare "  " in senso antiorario per impostare il tempo di cottura con una potenza del 100%, quindi premere "  +30" " per avviare la cottura.



5. Scongelamento con impostazione del peso

- 1) Premere una volta "  |  " ; sul forno viene visualizzato "dEF1".

- 2) Ruotare "  " per selezionare il peso del cibo da scongelare (peso compreso tra 100g e 2000g).

- 3) Premere "  +30" " per avviare lo scongelamento.

6. Scongelamento con impostazione del tempo

- 1) Premere due volte "  |  " ; sul forno viene visualizzato "dEF2".

- 2) Ruotare "  " per selezionare il tempo di scongelamento.

- 3) Premere "  +30" " per avviare lo scongelamento.

7. Menu automatico

- 1) Ruotare "  " verso destra per selezionare il menu; verranno visualizzati i menu da "A-1" ad " A-10 " , corrispondenti rispettivamente a pizza, Patate , Carne , Pesce , Verdure, Bevanda , Pasta , Popcorn e Pollo

- 2) Premere "  +30" " per confermare.

- 3) Ruotare "  " per scegliere il peso predefinito indicato nella tabella dei menu.

- 4) Premere "  +30" " per avviare la cottura.

Esempio: se si vuole utilizzare "Auto Menu" per cuocere un pesce di 350g:

- 1) Ruotare "  " in senso orario finché non viene visualizzato " A-4 " .

- 2) Premere "  +30" " per confermare.

3) Ruotare "  " per selezionare il peso del pesce finché non viene visualizzato "350".

4) Premere "  +30" " per avviare la cottura.

Tabella dei menu:

Menu	Peso	Display
A-1 Pizza	200 g	200 g
	400 g	400 g
A-2 Patate	200 g	200 g
	400 g	400 g
	600 g	600 g
A-3 Carne	250 g	250 g
	350 g	350 g
	450 g	450 g
A-4 Pesce	250 g	250 g
	350 g	350 g
	450 g	450 g
A-5 Verdure	200 g	200 g
	300 g	300 g
	400 g	400 g
A-6 Bevanda	1 (120ml)	1
	2 (240ml)	2
	3 (360ml)	3
A-7 Pasta	50g (con 450 di acqua fredda)	50g
	100g (con 800 di acqua fredda)	100g
A-8 Popcorn	50g	50g
	100g	100g
A-9 Pollo	200g	200g
	400g	400g
	600g	600g
	800g	800g
A-10 Riscaldare	200g	200g
	400g	400g
	600g	600g





8. Cottura programmata

1) Impostare prima l'orologio (consultare le istruzioni per l'impostazione dell'orario).

2) Inserire le impostazioni per la cottura programmata. È possibile impostare al massimo due stadi. Non è possibile selezionare lo scongelamento come impostazione per la cottura programmata.

Esempio: se si vuole cuocere con una potenza dell'80% per 7 minuti, procedere come segue:



a. Premere una volta "     "; sul display viene visualizzato "P100".

b. Premere "     " ancora una volta o ruotare "  " per selezionare la potenza dell'80%.



c. Premere "  +30" " per confermare; sul display viene visualizzato "P80".

d) Ruotare "  " per regolare il tempo di cottura finché sul display del forno non viene visualizzato "7:00".

Dopo aver seguito la operazioni descritte sopra, fare attenzione a non premere "  +30" " per avviare la cottura.

3) Premere "  |  " ; le cifre che indicano l'ora lampeggiano.

4) Ruotare "  " per regolare l'ora, scegliendo un numero compreso tra 0 e 23.

5) Premere "  |  " ; le cifre che indicano i minuti lampeggiano.



6) Ruotare "  " per regolare i minuti, scegliendo un numero compreso tra 0 e 59.

7) Premere "  +30" " per completare l'impostazione. Se lo sportello è chiuso, quando l'orologio segna l'orario indicato vengono emessi due segnali acustici, quindi la cottura inizierà automaticamente.

9. Cottura multisessione





Per la cottura possono essere impostate al massimo due sessioni. Con la cottura multisessione, se una delle modalità selezionate è lo scongelamento, tale modalità verrà assegnata alla prima sessione.

Esempio: se si vuole scongelare del cibo in 5 minuti e quindi cuocere ad una potenza dell'80% per 7 minuti, procedere come segue:

1) Premere due volte "  |  " ; sul display viene visualizzato "dEF2".

2) Ruotare "  " per selezionare il tempo di scongelamento finché non verrà visualizzato "5:00".

3) Premere una volta "  |  |  " ; sul display viene visualizzato "P100".



4) Premere "  |  |  " ancora una volta o ruotare "  " per selezionare l'80% di potenza.

5) Premere "  +30" " per confermare; sul display viene visualizzato "P80".

6) Ruotare "  " per regolare il tempo di cottura finché sul display del forno non verrà visualizzato "7:00".

7) Premere "  +30" " per avviare la cottura. Viene emesso un primo segnale acustico per indicare l'inizio della prima sessione, dopodiché inizierà il conto alla rovescia del tempo impostato per lo scongelamento, trascorso il quale verrà emesso un secondo segnale acustico che precederà l'avvio della seconda sessione di cottura. Al termine della cottura, verranno emessi cinque segnali acustici..



10. Visualizzazione informazioni

(1) Se si preme "  |  |  " nelle modalità di cottura microonde, grill o combinata, viene visualizzata per 3 secondi la potenza di alimentazione. Trascorsi 3 secondi, il forno tornerà allo stato precedente.

(2) Durante la cottura, se si preme "  |  " verrà visualizzata l'ora per 3 secondi.

(3) In modalità di cottura programmata, se si preme "  |  " viene visualizzato per 3 secondi l'orario di avvio della cottura.

11. Funzione di blocco per i bambini

Attivazione della funzione di blocco: in modalità di attesa, premere "  STOP " per 3 secondi; il forno emetterà un segnale acustico prolungato ad indicare che il forno è in modalità di blocco. Se impostata, viene visualizzata l'ora, altrimenti sul display viene visualizzato "  ".

Disattivazione dalla funzione di blocco: nella modalità di blocco, premere "  STOP " per 3 secondi; il forno emetterà un segnale acustico prolungato ad indicare che la funzione è stata disattivata.

Ricerca dei problemi

Se si verifica un guasto, prima di chiamare l'assistenza, effettuare le seguenti verifiche.

NORMALE	
Interferenza del forno a microonde con la ricezione televisiva	E' possibile che vi siano interferenze con la ricezione di radio o televisione nel corso del funzionamento del forno a microonde. Si tratta di un fenomeno simile a quello possibile con altri piccoli elettrodomestici, quali miscelatori, aspirapolvere, ventilatori elettrici. Si tratta di una condizione normale.
Luce affievolita	Nel corso di cotture a microonde a bassa pressione, la luce del forno può affievolirsi. Si tratta di una condizione normale.
Si accumula del vapore sulla porta, esce aria calda dalle aperture di sfianto	Nel corso della cottura, è possibile che del vapore fuoriesca dal cibo. Buona parte di questo vapore viene espulso dalle aperture di sfianto. Ma parte del vapore potrebbe accumularsi sulle superfici fredde, quali per esempio la porta del forno. Si tratta di una condizione normale.
Il forno viene acceso accidentalmente senza che vi sia del cibo all'interno dello stesso	Il funzionamento per periodi limitati del forno senza che al proprio interno vi sia del cibo non crea alcun danno al forno stesso. Questa condizione, però, dovrebbe essere evitata.

Problema	Possibile causa	Rimedio
Il forno non si accende	Il cavo di alimentazione non è inserito correttamente nella presa di corrente	Staccare la spina dalla presa, quindi ricollegare dopo 10 secondi
	Il fusibile salta o entra in funzione l'interruttore automatico	Sostituire il fusibile o ripristinare l'interruttore automatico (riparato da personale qualificato della nostra società)
	Problemi con l'uscita	Verificare l'uscita con un altro elettrodomestico
Il forno non scalda	La porta non è chiusa correttamente	Chiudere bene la porta
Il piatto di vetro è rumoroso durante il funzionamento del forno	Rulli sporchi e residui sul fondo del forno	Fare riferimento al paragrafo "manutenzione del microonde" per pulire le parti sporche.



Questa apparecchiatura è marchiata secondo la Direttiva Europea 2002/96/CE per lo smaltimento delle apparecchiature elettriche ed elettroniche (Waste Electrical and Electronic Equipment, WEEE).
Facendo in modo che questo prodotto venga smaltito correttamente aiuterete a prevenire potenziali conseguenze negative per l'ambiente e la salute dell'uomo, che potrebbero essere causate da uno smaltimento non corretto. Il simbolo su questo prodotto indica che esso non deve essere trattato come rifiuto domestico. L'elettrodomestico deve essere consegnato al punto di raccolta predisposto per il riciclo delle apparecchiature elettriche ed elettroniche. Lo smaltimento deve avvenire secondo le norme locali vigenti sullo smaltimento dei rifiuti. Per maggiori informazioni sul trattamento, il ritiro e il riciclo di questo prodotto consultare le autorità comunali, il servizio per la raccolta dei rifiuti o il negozio in cui il prodotto è stato acquistato.

SERVIZIO ASSISTENZA CLIENTI

CERTIFICATO DI GARANZIA CONVENZIONALE: cosa fare?

Il Suo prodotto è garantito, alle condizioni e nei termini riportati sul certificato inserito nel prodotto ed in base alle previsioni del decreto legislativo 24/02, nonché del decreto legislativo 6 settembre 2005, n. 206, per un periodo di 24 mesi decorrenti dalla data di consegna del bene.

Così come riportato nei testi dei Decreti Legislativi citati, il certificato di garanzia dovrà essere da Lei conservato, debitamente compilato, per essere mostrato al Servizio Assistenza Tecnica Autorizzato, in caso di necessità, unitamente ad un documento fiscalmente valido rilasciato dal rivenditore al momento dell'acquisto (bolla di consegna, fattura, scontrino fiscale, altro) sul quale siano indicati il nominativo del rivenditore, la data di consegna, gli estremi identificativi del prodotto ed il prezzo di cessione

Resta pure inteso che, salvo prova contraria, poiché si presume che i difetti di conformità che si manifestano entro sei mesi dalla consegna del bene esistessero già a tale data, a meno che tale ipotesi sia incompatibile con la natura del bene o con la natura del difetto di conformità, il Servizio di Assistenza Tecnica Autorizzato Gias, verificato il diritto all'intervento, lo effettuerà senza addebitare il diritto fisso di intervento a domicilio, la manodopera ed i ricambi. Per contro, nel successivo periodo di diciotto mesi di vigenza della garanzia, sarà invece onere del consumatore che intenda fruire dei rimedi accordati dalla garanzia stessa provare l'esistenza del difetto di conformità del bene sin dal momento della consegna; nel caso in cui il consumatore non fosse in grado di fornire detta prova, non potranno essere applicate le condizioni di garanzia previste e pertanto il Servizio di Assistenza Tecnica Autorizzato Gias effettuerà l'intervento addebitando al consumatore tutti i costi relativi.

ESTENSIONE DELLA GARANZIA FINO A 5 ANNI : come?

Le ricordiamo inoltre che sullo stesso certificato di garanzia convenzionale Lei troverà le informazioni ed i documenti necessari per prolungare la garanzia dell'apparecchio sino a 5 anni e così, in caso di guasto, non pagare il diritto fisso di intervento a domicilio, la manodopera ed i ricambi.

Per qualsiasi informazione necessitasse, La preghiamo rivolgersi al numero telefonico del Servizio Clienti 199121314.

ANOMALIE E MALFUNZIONAMENTI: a chi rivolgersi ?

Per qualsiasi necessità il centro assistenza autorizzato è a Sua completa disposizione per fornirLe i chiarimenti necessari; comunque qualora il Suo prodotto presenti anomalie o mal funzionamenti, prima di rivolgersi al Servizio Assistenza Autorizzato, consigliamo **vivamente** di effettuare i controlli indicati sopra.

UN SOLO NUMERO TELEFONICO PER OTTENERE ASSISTENZA. Qualora il problema dovesse persistere, componendo il "Numero Utile" sotto indicato, sarà messo in contatto direttamente con il



Servizio Assistenza Tecnica Autorizzato che opera nella Sua zona di residenza. Attenzione, la chiamata è a pagamento; il costo verrà comunicato, tramite messaggio vocale, dal Servizio clienti dell'operatore telefonico utilizzato. Dettagli sono presenti sul sito internet www.candy.it

MATRICOLA DEL PRODOTTO. Dove si trova?

E' indispensabile che comunichi al Servizio Assistenza Tecnica Autorizzato la sigla del prodotto ed il numero di matricola (16 caratteri che iniziano con la cifra 3) che troverà sul certificato di garanzia.

In questo modo Lei potrà contribuire ad evitare trasferite inutili del tecnico, risparmiando oltretutto i relativi costi.



Mikrowellenherd

BEDIENUNGSANWEISUNG

**MODELES: MIC 20G DFX
MIC 20G DFN**

Vor der Verwendung des Mikrowellenherdes vorsichtig diese Bedienungen lesen und sie sorgfältig bewahren.

Wenn Sie die hier enthaltenen Bedienungen folgen, wird Ihr Mikrowellenherd Ihnen einen hervorragenden Dienst für lange Zeit garantieren.

DIESE BEDIENUNGEN SORGFÄLTIG BEWAHREN.

VERMEIDUNG von möglicher Mikrowellenstrahlung

(a) Versuchen Sie nicht, diesen Ofen bei geöffneter Tür zu betreiben, da dies zu schädlicher Mikrowellenstrahlung führen kann. Es ist wichtig, die Sicherheitsperren nicht zu brechen oder zu manipulieren.

(b) Stellen Sie keine Gegenstände zwischen die Backofen-Vorderseite und die Tür, vermeiden Sie Schmutz oder Rückstände von Reinigungsmitteln auf Dichtungen.

(c) **ACHTUNG:** Wenn die Tür oder Türdichtungen beschädigt sind, darf der Ofen nicht betrieben werden bis dieser von einer sachkundigen Person repariert worden ist.

ANHANG

Wenn das Gerät nicht sauber gehalten wird, können die Oberflächen angegriffen werden und beeinflussen dann die Lebensdauer des Gerätes und können zu gefährlichen Situationen führen.

Technische Verzeichnisse

Modellen	MIC 20G DFX MIC 20G DFN
Nennspannung	230V~50Hz
Eingangsnennleistung (Mikrowellen)	1250W
Ausgangsnennleistung (Mikrowellen)	800 W
Eingangsnennleistung (Grill)	1000 W
Kapazität des Mikrowellenherdes	20 L
Durchmesser des Drehtellers	∅ 245mm
Außengrößen (LxTxH)	594 x 345 x 388 mm
Nettogewicht	15 kg

Wichtige Sicherheitshinweise

WARNUNG

Um die Gefahr von Feuer, elektrischem Schlag, Verletzungen von Personen oder übermäßiger Mikrowellen-Strahlung zu verhindern, wenn Sie Ihr Gerät anschließen, befolgen Sie die grundlegenden Vorsichtsmaßnahmen, einschließlich der Folgenden:

1. Achtung: Flüssigkeiten und andere Lebensmittel dürfen nicht in verschlossenen Gefäßen erhitzt werden, da sie explodieren könnten.
2. Achtung: Die Abdeckung, die Schutz gegen die Strahlenbelastung durch Mikrowellenenergie bietet, nicht entfernen.
3. Achtung: Nur Kinder dürfen den Ofen ohne Aufsicht benutzen, wenn eine angemessene Anweisung gegeben worden ist, so dass das Kind in der Lage ist, den Ofen in einer sicheren Weise zu nutzen und die Gefahren eines unsachgemäßen Gebrauchs zu verstehen.
4. Achtung: Wenn das Gerät im Kombinationsmodus betrieben wird, sollten Kinder den Backofen nur unter Aufsicht von Erwachsenen nutzen. (Nur für Grill-Serie)
5. Verwenden Sie nur Behälter, die für den Einsatz in der Mikrowelle geeignet sind.
6. Der Ofen sollte regelmäßig gereinigt werden und jegliche Nahrungsrückstände sollten entfernt werden.
7. Lesen und beachten Sie im Besonderen:
"Vorsichtsmaßnahmen zur Vermeidung von möglicher Mikrowellenstrahlung".
8. Beim Erhitzen von Speisen in Kunststoff- oder Papier-Behältern, besteht die Möglichkeit der Entzündung.

9. Wird Rauch festgestellt, das Gerät ausschalten oder den Netzstecker ziehen und die Tür geschlossen halten, um eventuelle Flammen zu ersticken.
10. Überhitzen Sie das Essen nicht.
11. Nutzen Sie das Gerät nicht als Stauraum für Gegenstände, Brot, Kekse etc.
12. Entfernen Sie Drahtbänder und Metallteile von Papier- oder Plastikbehältern bevor Sie diese in den Ofen stellen.
13. Installieren Sie oder stellen Sie diesen Ofen nur entsprechend den Installationsanweisungen auf.
14. Eier in Schale und ganze hartgekochte Eier sollten nicht in der Mikrowelle erwärmt werden, da sie explodieren können, selbst nachdem die Mikrowellenerhitzung beendet ist.
15. Benutzen Sie dieses Gerät nur für die vorgesehenen Verwendungen wie in dieser Anleitung beschrieben. Verwenden Sie keine ätzenden Chemikalien oder Dampfreiniger. Dieser Ofen ist speziell für die Erhitzung von Lebensmitteln und nicht für den industriellen oder Labor-Gebrauch konzipiert.
16. Wenn das Netzkabel beschädigt ist, muss es vom Hersteller, dessen Kundendienst oder einer ähnlich qualifizierten Person ersetzt werden, um Gefährdungen zu vermeiden.
17. Bewahren oder benutzen Sie dieses Gerät nicht im Freien.
18. Verwenden Sie dieses Gerät nicht in der Nähe von Wasser, in einem feuchten Keller oder in der Nähe eines Schwimmbeckens.

19. Die Temperatur der zugänglichen Oberflächen kann hoch sein, wenn das Gerät in Betrieb ist. Halten Sie das Kabel fern von erhitzten Oberfläche und bedecken Sie nicht die Lüftungsschlitze des Ofen.
20. Das Kabel darf nicht über Tischkanten hängen.
21. Wird das Gerät nicht sauber gehalten, könnte es zu einer Verschlechterung der Oberfläche kommen, die Lebensdauer des Gerätes könnte beeinträchtigt werden und dies möglicherweise zu einer gefährlichen Situation führen.
22. Der Inhalt von Babyflaschen und Gläschen mit Babynahrung sind zu rühren oder zu schütteln und die Temperatur vor dem Verzehr zu überprüfen, um Verbrennungen zu vermeiden.
23. Erhitzen von Getränken in der Mikrowelle kann zu verspätetem siedendem Aufwallen führen, also Vorsicht beim Umgang mit dem Behälter.
24. Das Gerät ist nicht für die Nutzung durch Personen (einschließlich Kinder) mit eingeschränkten physischen, sensorischen oder geistigen Fähigkeiten oder mangels Erfahrung und Wissen, nur wenn eine angemessene Aufsicht oder ausführliche Anleitung zur Benutzung des Geräts durch eine verantwortliche Person gegeben wurde.
25. Kinder sollten beaufsichtigt werden, um sicherzustellen, dass sie nicht mit dem Gerät spielen.
26. Die Geräte sollen nicht durch eine externe Zeitschaltuhr oder eine Remote-Steuerung betrieben werden.

27. ACHTUNG: Stellen Sie sicher, dass das Gerät ausgeschaltet ist, bevor Sie die Lampe austauschen, um die Möglichkeit eines elektrischen Schlages zu vermeiden.

28. Zugängliche Teile können während der Benutzung heiß werden. Kleine Kinder sollten daher ferngehalten werden.

29. Verwenden Sie keine scharfen Scheuermittel oder scharfe Metallschaber zur Reinigung der Ofentür, da sie die Oberfläche zerkratzen und zur Beschädigung des Glases führen kann.

30. Während des Gebrauchs wird das Gerät heiß. Berührungen mit Elementen im Inneren des Ofens sind zu vermeiden.

31. Verwenden Sie nur die Temperaturfühler, die für dieses Gerät empfohlen sind (gilt für Öfen mit einer vorgesehenen Anlage zur Nutzung einer Temperaturfühlers.)

32. Die Rückseite des Geräts sollte an eine Wand gestellt werden.

33. Dieses Gerät kann von Kindern ab dem Alter von 8 Jahren oder mehr benutzt werden, ebenso wie von Personen mit geminderter sensorischer oder geistiger Fähigkeit oder fehlender Erfahrung und Wissen, falls sie Beaufsichtigung oder Einweisung zum sicheren Benutzen dieses Gerätes bekommen haben, und auf die entsprechenden Gefahren hingewiesen wurden. Kinder sollen nicht mit dem Gerät spielen. Die Reinigung und Instandhaltung seitens des Benutzers soll nicht von Kindern ohne Aufsicht vorgenommen werden.

34. Das Gerät und das Stromkabel sollen außerhalb der Reichweite von Kindern unter 8 Jahren aufbewahrt werden.

35. Falls sich Rauch entwickelt, schalten Sie das Gerät ab oder ziehen Sie den Netzstecker, lassen Sie die Tür geschlossen, um etwaige Flammen zu ersticken.

36. Dieses Gerät ist für den Gebrauch im Haushalt und ähnlichen Anwendungen bestimmt:

- Essräume des Personals in Werkstätten, Büros und anderen Arbeitsumgebungen;
- Durch Kunden in Hotels, Motels und ähnlichen Wohnumgebungen;
- Bauernhöfe;
- Frühstückspension.

37. **WARNUNG:** Das Gerät und seine zugänglichen Teile werden während der Benutzung heiß. Seien Sie vorsichtig und berühren Sie nicht die Heizelemente. Kinder unter 8 Jahren sollen ohne konstante Aufsicht nicht in der Nähe sein.

38. Die Mikrowelle soll mit geöffneter Dekor Tür benutzt werden (für Mikrowellen mit Dekor Tür).

39. Der Dampfreiniger soll nicht benutzt werden.

40. Die Oberfläche des Staufachs kann heiß werden.

41. Benutzen Sie keine scheuernden Reinigungsmittel oder scharfe Metallkratzer, um die Ofenglastür zu säubern. Dies verursacht Oberflächenkratzer, die zu einem Zerschneiden des Glases führen können.

**BITTE LESEN SIE DIES SORGFÄLTIG UND
BEWAHREN SIE ES FÜR SPÄTERES NACHLESEN AUF**

Zur Vermeidung von Personenschäden

GEFAHR

Stromschlaggefahr
Berühren der internen
Komponenten kann zu
schweren Verletzungen
oder zu Tod führen.
Öffnen Sie dieses Gerät
nicht!

WARNUNG

Stromschlaggefahr
Bei unsachgemäßem
Gebrauch der Erdung kann
es zu einem elektrischen
Schlag kommen.
Das Gerät nicht in die
Steckdose anschließen
bis Gerät korrekt installiert
und geerdet ist.

Reinigung

Bitte ziehen Sie den
Stecker vor der Reinigung

1. Reinigen Sie das Innere
mit einem feuchten Tuch.
2. Reinigen Sie das
Zubehör in Seifenlauge.
3. Der Türrahmen und die
Dichtung müssen vorsichtig
mit einem feuchten Tuch
gereinigt werden, wenn Sie
dreckig sind.

Dieses Gerät muss geerdet
werden. Im Falle eines elektrischen
Kurzschlusses, reduziert die
Erdung den elektrischen Strom.
Dieses Gerät ist mit einem
Erdungskabel und mit einem
Schutzkontaktstecker ausgestattet.
Der Stecker muss an eine
Steckdose angeschlossen werden,
die ordnungsgemäß installiert und
geerdet ist. Wenden Sie sich an
einen qualifizierten Elektriker oder
Kundendienst-techniker, wenn die
Anweisungen nicht vollständig
verstanden wurden oder wenn
Zweifel bestehen, ob das Gerät
ordnungsgemäß geerdet ist.

1. Ein kurzes Anschlusskabel wird
mitgeliefert, um Risiken des
Stolperns über ein langes Kabel zu
vermeiden.
2. Wenn ein längeres Kabel oder
Verlängerungskabel genutzt wird:
 - 1) Die vermerkte Spannung des
Kabels oder Verlängerungskabels
sollte mindestens so groß sein wie
die elektrische Leistung des Gerätes.
 - 2) Das Verlängerungskabel muss
ein geerdeter 3-Draht-Kabel sein.
 - 3) Das lange Kabel sollten so
platziert werden, dass es von
Kindern nicht gezogen werden
kann oder unabsichtlich darüber
gestolpert werden kann.

WERKZEUGE

ACHTUNG

Schadengefahr den Menschen

Ohne eine Fachkenntnis ist es gefährlich, Ausbesserungen oder Wartungen zu machen, die die Verschiebung eines Deckels vorsehen, der ein Schutz gegen die Mikrowellen garantiert.

Beziehen Sie sich auf die Bedienungsleitungen im Abschnitt "geeignete Materialien für den Mikrowellenherd oder ungeeignete Materialien für den Mikrowellenherd".

Auch Werkzeuge ohne Metall könnten ungeeignet für die Verwendung im Mikrowellenherd sein. Im Zweifelfalle ist es möglich, das betreffende Werkzeug mit der folgenden Prozedur zu testen.

Werkzeugentest:

1. einen für den Mikrowellenherd geeigneten Behälter mit einer Tasse kalten Wassers (250 ml.) und mit dem betreffenden Werkzeug füllen.
2. Zur höchsten Temperatur für 1 Min. kochen.
3. Vorsichtig das Werkzeug berühren. Wenn das leere Werkzeug warm ist, muß er nicht im Mikrowellenherd verwendet werden.
4. **Die Kochzeit von 1 Min. nicht übersteigen.**

Geeignete Materialien für das Mikrowellenherd

Aluminiumfolie	Nur für Schutz. Kleine glatte Stücke können als Decke von dünnen Fleisch- oder Geflügelstücken verwendet werden, damit ein überhohotes Kochen verhütet wird. Wenn die Aluminiumfolie zu nah den Wänden des Mikrowellenherdes ist, kann sie bogenförmig sich biegen. Die Aluminiumfolie sollte wenigstens 1 Zoll (2,5 cm.) weit von den Wänden des Mikrowellenherdes positioniert werden.
Behälter in Terracotta	Die Bedienungsanleitungen des Herstellers folgen. Der Boden eines Terracotta-Behälters muß wenigstens 3/16 Zoll (5 mm.) über die Drehplatte positioniert werden. Wegen einer falschen Verwendung kann die Drehplatte brechen.
Tischteller	Nur diejenigen, die geeignet für die Mikrowellenherde sind. Die Bedienungsanleitungen des Herstellers folgen. Keine gebrochene oder abgeschlagene Teller verwenden.
Glasgefäße	Immer den Deckel wegnehmen. Nur um Erwärmung des Essen verwenden. Viele Glasgefäße sind nicht hitzefest und könnten brechen.
Glasartikel	Nur hitzefeste und für den Mikrowellenherd geeignete Glasartikel verwenden. Versichern Sie sich, daß es keine Metallbesätze gibt. Keine gebrochene oder abgeschlagene Teller verwenden.
Taschen für das Kochen im Mikrowellenherd	Die Bedienungsanleitungen des Herstellers folgen. Mit Metallverschlüsse nicht schließen. Einige Schnitte machen, damit der Dampf austreten kann.
Papiertassen und Papierteller	Fürs Kochen oder Warmen nur für wenige Zeit. Während des Kochens den Mikrowellenherd unbewacht nicht lassen.

Papierservietten	Sie können als Decke des Essens während des Wärmens verwendet werden, um eventuelle Fetten zu absorbieren. Nur für kurze Warmen unter Kontrolle verwenden.
Pergamentpapier	Als Decke für das Verhüten der Spritzer oder als Decke für den Dampf verwenden.
Kunststoff	Nur den für die Mikrowellenherde geeigneten Typ. Die Bedienungsanleitungen des Herstellers folgen. Der Kunststoff sollte mit dem Zeichen „Für Mikrowellen geeignet“ markiert werden. Einige Kunststoffbehälter werden weich als das enthaltene Essen sich wärmt. Dichtverschlossene Tüte fürs Kochen und Plastiktüte sollten geschnitten oder gelocht werden wie auf der Verpackung gezeigt.
Plastikfolie	Nur den für die Mikrowellenherde geeigneten Typ. Für das Decken des Essens während des Kochens verwendet, um die Feuchtigkeit zu halten. Versichern Sie sich, daß die Plastikfolie das Essen nicht berührt.
Thermometer	Nur die für die Mikrowellenherde geeigneten Thermometer (für Fleisch und Süßigkeiten).
Butterbrotpapier	Als Decke für das Verhüten der Spritzer und für das Halten der Feuchtigkeit verwenden.

Ungeeignete Materialien für die Mikrowellenherde

Aluminiumtablette	Sie können sich bogenförmig biegen. Das Essen auf die für die Mikrowellenherde geeigneten Teller legen.
Pappbehälter für Essen mit Metallhandgriffen	Sie können sich bogenförmig biegen. Das Essen auf die für die Mikrowellenherde geeigneten Teller legen.
Metallwerkzeuge	Das Metall schützt das Essen vor der Mikrowellenenergie. Das Metall kann sich bogenförmig biegen.
Metallverschlüsse	Sie können sich bogenförmig biegen und könnten eine Brandstiftung innerhalb dem Mikrowellenherd verursachen.
Papiertüte	Sie könnten eine Brandstiftung innerhalb dem Mikrowellenherd verursachen.
Polystyren-oder Polyurethanbehälter	Wenn diese Behälter zu hohen Temperaturen ausgesetzt werden, könnten sie schmelzen oder die Innenflüssigkeit kontaminieren.
Holz	Nachdem das Holz im Mikrowellenherd verwendet wird, trocknet es sich und könnte reißen werden oder brechen.

WIE IHREN MIKROWELLENHERD ZU INSTALLIEREN

Namen von den Teilen und der Zubehören des Mikrowellenherdes

Das Mikrowellenherd und alle Teile aus der Verpackung sowie aus der Höhlung des Mikrowellenherdes ziehen.

Das Mikrowellenherd wird mit den folgenden Zubehören geliefert:

- 1 Glasdrehplatte
- 1 Drehring
- 1 Bedienungsanleitung

- A) Schaltplatte
- B) Welle der Drehplatte
- C) Trägersring
- D) Glasplatte
- E) Betrachtungsfenster
- F) Tür
- G) Sicherheitsblockierungssystem

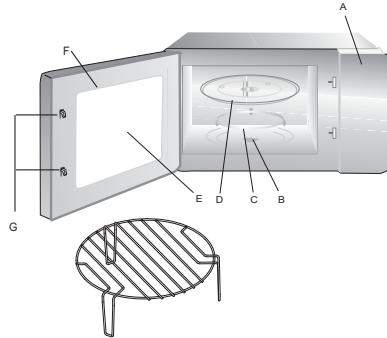

Grill (nur für die Serie Grill)

Achtung: das Metallgitter im Mikrowellenmodell nicht verwenden. Wenn die Mikrowellenfunktion gewählt wird, das Metallgitter immer wegnehmen.

Wenn die Tür während der Arbeitsweise offen bleibt, muß das Mikrowellenherd abgeschaltet werden.

Installation der Drehplatte

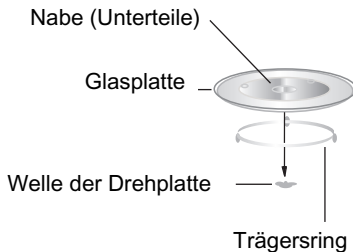

- a. Die Glasplatte falsch herum nie stellen. Die Glasplatte sollte nie gebunden werden.
- b. Sowohl die Glasplatte als auch der Trägerring müssen immer während des Kochens benutzt werden.
- c. Das Essen und die Behälter müssen immer auf die Glasplatte fürs Kochen gestellt werden.
- d. Wenn die Glasplatte oder der Drehring und die Drehplatte brechen oder sich biegen würden, wenden Sie sich am nächsten Kundendienst.

Installation und Anschluss

1. Dieses Gerät ist für den Privatgebrauch vorgesehen.
2. Dieses Gerät ist als Einbaugerät vorgesehen. Es eignet sich nicht für die Verwendung auf einer Küchenablagefläche oder in einem geschlossenen Küchenschrank.
3. Die spezifischen Installationsanleitungen bitte einhalten.
4. Das Gerät in einem 60 cm breiten Wandschrank installieren (Tiefe mindestens 55 cm, Höhe ab Boden 85 cm).
5. Dieses Gerät ist mit einem Stecker ausgerüstet, der nur an eine korrekt geerdete Steckdose angeschlossen werden darf.
6. Die diesbezügliche Spannung hat der auf dem Typenschild wiedergegebenen Spannung zu entsprechen.
7. Die Steckdose darf nur von einem qualifizierten Elektriker installiert werden. Dies gilt auch für den etwaigen Ersatz des Anschlusskabels. Wenn der Stecker nach der Installation nicht mehr zugänglich ist, muss sich installationsseitig ein allpoliger Stromkreisunterbrecher befinden, der einen Kontaktabstand von mindestens 3 mm aufweist.
8. Keine Adapter, Mehrfachsteckdosen und Verlängerungskabel verwenden. Die Überladung des Geräts stellt ein potentiellies Brandrisiko dar.

**Die zugänglichen Flächen
des Gerätes können bei
Gebrauch heiß werden.**





Funktionen

1. Uhr einstellen



Wenn das Mikrowellengerät an das Stromnetz angeschlossen wird, blendet der LED-Display die Anzeige „0:00“ ein. Der Summer sendet ein akustisches Signal aus.

1) "  |  " drücken. Die Stundenanzeige blinkt.

2) Den Wählschalter "  " drehen, um die Stunden einzustellen. Hierbei einen Wert zwischen 0--23 festlegen.

3) "  |  " drücken. Die Minutenanzeige blinkt.



4) Den Wählschalter "  " drehen, um die Minuten einzustellen. Hierbei einen Wert zwischen 0--59 festlegen.





5) "  |  " drücken, um die Einstellung der Uhr zu beenden. ":" blinkt und die Uhr schaltet auf Dauerlicht.

Hinweis: 1) Die Uhr ist auch bei Spannungsführung deaktiviert, wenn sie nicht eingestellt wurde.

2) Wenn bei der Einstellung der Uhr die Schaltfläche "  STOP " gedrückt wird, kehrt das Gerät automatisch zum vorhergehenden Status zurück.

2. Zubereiten von Speisen im Mikrowellengerät

1) "  |  |  " drücken. Der LED-Display blendet die Anzeige "P100" ein.



"  |  |  " mehrere Male drücken oder den Wählschalter "  " drehen, um die Leistungsstufe





festzulegen. Der Display zeigt bei jedem Drücken jeweils die Anzeige "P100", "P80", "P50", "P30" oder "P10" an. An

dieser Stelle die gewünschte Stufe durch das Drücken der Schaltfläche "  +30" " bestätigen und

den Wählschalter auf die gewünschte Garzeit drehen (0:05 bis 95:00). "  +30" " erneut drücken, um den Garvorgang zu starten.

Beispiel: Sie möchten eine Mikrowellen-Leistungsstufe von 80 % bei einer Garzeit von 20 Minuten festlegen. Gehen Sie folgenderweise vor:

1) "  |  |  " drücken. Der LED-Display blendet die Anzeige "P100" ein.

2) "  |  |  " erneut drücken und den Wählschalter "  " drehen, um die Mikrowellen-Leistungsstufe (80 %) festzulegen.

3) Zur Bestätigung der Auswahl "  +30" " drücken. Der LED-Display blendet die Anzeige "P80" ein.

4) Zur Einstellung der Garzeit den Wählschalter "  " so lange drehen, bis der LED-Display den Wert "20:00" anzeigt.



5) "  +30" " drücken, um den Garvorgang zu starten.



Hinweis: Die Stufen des Wählschalters sind in folgende Abfolgen aufgeteilt:

0---1 Min.	: 5 Sekunden
1---5 Min.	: 10 Sekunden
5---10 Min.	: 30 Sekunden
10---30 Min.	: 1 Minute
30---95 Min.	: 5 Minuten

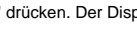
„  Stufen “	Displayanzeige	Leistungsstufe Mikrowelle	Leistungsstufe Grill
1	P100	100 %	
2	P80	80 %	
3	P50	50 %	
4	P30	30 %	
5	P10	10 %	
6	G	0 %	100 %
7	C-1	55 %	45 %
8	C-2	36 %	64 %

3. Zubereiten von Speisen mit den Funktionen Grill/Kombi



"  " drücken. Der Display zeigt die Anzeige "P100" an. Die Schaltfläche "  " mehrere Male drücken oder den Wählschalter  drehen, um die Leistungsstufe

festzulegen. Der Display zeigt bei jedem Drücken jeweils die Anzeige "G", "C-1" oder "C-2" an. An dieser Stelle die Auswahl durch das Drücken der Schaltfläche "  +30" " bestätigen und den Wählschalter  auf

die gewünschte Garzeit drehen (0:05 bis 95:00). "  +30" " erneut drücken, um den Garvorgang zu starten.

Beispiel: Sie möchten eine Mikrowellen-Leistungsstufe von 55 % und eine Grill-Leistungsstufe (C-1) von 45 % bei einer Garzeit von 10 Minuten festlegen. Gehen Sie folgenderweise vor:

1) "  " drücken. Der LED-Display blendet die Anzeige "P100" ein.

2) "  " erneut drücken oder den Wählschalter  drehen, um die Funktion Kombi festzulegen.

3) "  +30" " zur Bestätigung der Auswahl drücken. Der LED-Display blendet die Anzeige "C-1" ein.





4) Zur Einstellung der Garzeit den Wählschalter "  " so lange drehen, bis der LED-Display den Wert "10:00" anzeigt.

5) "  +30" " drücken, um den Garvorgang zu starten.



Hinweis: Nach der halben Garzeit sendet das Gerät zwei akustische Signale aus. Dies ist völlig normal.

Zur optimalen Garung im Grill, das Grillgut an dieser Stelle wenden, die Türe wieder schließen und den Garvorgang zu Ende führen.

4. Funktion Quick Start

- 1) Im Pausestatus "  +30" " drücken, um den Garvorgang bei einer Leistungsstufe von 100 % zu starten. Jedes Drücken erhöht die Garzeit um 30 Sekunden bis zu einem Maximum von 95 Minuten.
- 2) Beim Garen mit den Funktionen Mikrowelle, Grill, Kombi oder Auftauen erhöht das Drücken der Schaltfläche "  +30" " die Garzeit um jeweils 30 Sekunden.
- 3) Im Pausestatus den Wählschalter "  " nach links drehen, um den Garvorgang bei einer Mikrowellen-Leistungsstufe von 100 % einzustellen. "  +30" " drücken, um den Garvorgang zu starten.



5. Auftauen auf der Grundlage des Gewichtes

- 1) "  |  " drücken. Der LED-Display blendet die Anzeige "dEF1" ein.

- 2) Den Wählschalter "  " zur Festlegung des Gewichtes des Garguts drehen (100 bis 2000 g).

- 3) "  +30" " drücken, um den Auftauvorgang zu starten.

6. Auftauen auf der Grundlage der Zeit

- 1) "  |  " zwei Mal drücken. Der LED-Display blendet die Anzeige "dEF2" ein.

- 2) Den Wählschalter "  " drehen, um die Auftauzeit festzulegen.

- 3) "  +30" " drücken, um den Auftauvorgang zu starten.

7. Funktion Auto Menü

- 1) Den Wählschalter "  " zur Festlegung des Menüs nach rechts drehen. Der LED-Display blendet die Anzeigen "A-1" bis "A-10" (Pizza, Kartoffeln, Fleisch, Fisch, Gemüse, Getränk, Nudeln, Popcorn, Huhn und Erneutes Erhitzen) ein.

- 2) Die Auswahl durch das Drücken von "  +30" " bestätigen.

- 3) Den Wählschalter "  " zur Festlegung des Gewichtes entsprechend den Vorgaben der Menütafel drehen.

- 4) "  +30" " drücken, um den Garvorgang zu starten.
Beispiel: Sie möchten 350 g Fisch mit der Funktion „Auto Menu“ garen.

 - 1) "  " nach rechts drehen, bis der LED-Display die Anzeige "A-4" einblendet.

 - 2) Durch das Drücken von "  +30" " bestätigen.

3) Den Wählschalter "  " zur Festlegung des Gewichtes des Fisches drehen (350 g).

4) "  +30" " drücken, um den Garvorgang zu starten.

Menütabelle:





Menü	Gewicht	Anzeige
A-1 Pizza	200 g	200 g
	400 g	400 g
A-2 Kartoffeln	200 g	200 g
	400 g	400 g
	600 g	600 g
A-3 Fleisch	250 g	250 g
	350 g	350 g
	450 g	450 g
A-4 Fisch	250 g	250 g
	350 g	350 g
	450 g	450 g
A-5 Gemüse	200 g	200 g
	300 g	300 g
	400 g	400 g
A-6 Getränk	1 (120ml)	1
	2 (240ml)	2
	3 (360ml)	3
A-7 Nudeln	50 g (mit 450 g heißem Wasser)	50g
	100 g (mit 800 g heißem Wasser)	100g
A-8 Popcorn	50g	50g
	100g	100g
A-9 Huhn	200g	200g
	400g	400g
	600g	600g
	800g	800g
A-10 Emeutes Erhitzen	200g	200g
	400g	400g
	600g	600g



8. Funktion Vorprogrammieren



1) Zunächst die Uhr einstellen (siehe Anleitung zur Einstellung der Uhr).

2) Das Garprogramm eingeben. Es ist möglich, maximal zwei Stufen festzulegen. Die Auftaufunktion sollte nicht als Garprogramm festgelegt werden.

Beispiel: Sie möchten eine Mikrowellen-Leistungsstufe von 80 % bei einer Garzeit von 7 Minuten festlegen. Gehen Sie folgenderweise vor:

a) "  |  |  |  " drücken. Der LED-Display blendet die Anzeige "P100" ein.

b) "  |  |  |  " erneut drücken oder den Wählschalter  drehen, um die Leistungsstufe (80 %) festzulegen.

- c) "  +30" " zur Bestätigung der Auswahl drücken. Der LED-Display blendet die Anzeige "P80" ein.
- d) Zur Einstellung der Garzeit den Wählschalter "  " so lange drehen, bis der LED-Display den Wert "7:00" anzeigt.

An dieser Stelle "  +30" " drücken, um den Garvorgang zu starten.

- 3) "  |  " drücken. Die Stundenanzeige blinkt.

- 4) Den Wählschalter "  " drehen, um die Zeit einzustellen. Hierbei einen Wert zwischen 0--23 festlegen.

- 5) "  |  " drücken. Die Minutenanzeige blinkt.



- 6) Den Wählschalter "  " drehen, um die Minuten einzustellen. Hierbei einen Wert zwischen 0--59 festlegen.

- 7) "  +30" " drücken, um die Einstellung der Uhr zu beenden. Bei geschlossener Tür sendet der Summer bei Erreichen der festgelegten Zeit zwei akustische Signale aus. Danach startet der Garvorgang automatisch.



9. Funktion Mehrstufengaren





Es ist möglich, maximal zwei Stufen festzulegen. Wenn bei der Mehrstufengarung eine Stufe der Funktion „Auftauen“ entspricht, ist diese als erste festzulegen.

Beispiel: Sie möchten das Gericht 5 Minuten lang auftauen und danach eine Mikrowellen-Leistungsstufe von 80 % bei einer Garzeit von 7 Minuten festlegen. Gehen Sie folgenderweise vor:

- 1) "  |  " zwei Mal drücken. Der LED-Display blendet die Anzeige "dEF2" ein.

- 2) Den Wählschalter "  " so lange drehen, bis der LED-Display eine Auftauzeit von "5:00" anzeigt.

- 3) "  |  |  " drücken. Der LED-Display blendet die Anzeige "P100" ein.



- 4) "  |  |  " erneut drücken oder den Wählschalter "  " drehen, um die Mikrowellen-Leistungsstufe (80 %) festzulegen.



- 5) "  +30" " zur Bestätigung der Auswahl drücken. Der LED-Display blendet die Anzeige "P80" ein.



- 6) Zur Einstellung der Garzeit den Wählschalter "  " so lange drehen, bis der LED-Display den Wert "7:00" anzeigt.

- 7) "  +30" " drücken, um den Garvorgang zu starten. Der Summer sendet ein akustisches Signal für die erste Garstufe aus. Der Rückwärtszähler des Auftauvorgangs startet. Der Summer sendet bei der Aktivierung der zweiten Garstufe ein weiteres akustisches Signal aus. Nach Abschluss des Garvorgangs sendet der Summer fünf akustische Signale aus.



10. Funktion Prüfen

(1) Die Leistungsstufe wird für 3 Sekunden angezeigt, wenn in den Funktionen Mikrowelle, Grill und Kombi die Schaltfläche "  |  |  " gedrückt wird. Nach den besagten 3 Sekunden kehrt der Display zur ursprünglichen Anzeige zurück.

(2) Die Zeit wird für 3 Sekunden angezeigt, wenn beim Garvorgang die Schaltfläche "  |  " gedrückt wird.

(3) In der Funktion „Vorprogrammieren“ wird die vorprogrammierte Zeit beim Drücken der Schaltfläche "  |  " für 3 Sekunden angezeigt.

11. Funktion Kindersicherung

Sicherung aktivieren: Im Pausestatus "  STOP " 3 Sekunden lang drücken. Das Gerät sendet ein langes akustisches Signal aus, das darauf hinweist, dass die Kindersicherung aktiviert ist. Der LED-Display blendet die Sicherungsanzeige ein, wenn die Uhr eingestellt wurde, anderenfalls die Anzeige "  ".

Sicherung deaktivieren: Die Schaltfläche "  STOP " bei aktivierter Kindersicherung 3 Sekunden lang drücken. Das Gerät sendet ein langes akustisches Signal aus, das darauf hinweist, dass die Kindersicherung deaktiviert ist.

Problemsuche

Vor der Benachrichtigung des Kundendienstes anhand der folgenden Anweisungen zunächst selber versuchen etwaige Störungen zu beheben.

NORMAL	
Interferenz des Mikrowellenherdes mit dem Fernsehempfang	Während des Funktionierens des Mikrowellenherdes ist es möglich, daß es Empfangsstörungen und Bildinterferenzen gibt. Dasselbe passiert auch mit anderen kleinen Hausgeräten wie Mischer, Staubsauger, elektrische Ventilatoren. Es ist ganz normal.
Schwaches Licht	Während Mikrowellenkochen zu niedrigem Druck kann das Licht des Mikrowellenherdes schwächer werden. Es ist ganz normal.
Dampf sammelt sich auf der Tür an, warme Luft aus den Luftlochöffnungen ausgeht	Während des Kochens kann der Dampf aus dem Essen herausgehen. Ein Teil von diesem Dampf wird aus den Luftlochöffnungen ausgestoßen. Ein anderer Teil könnte sich auf die kalten Oberflächen wie z.B. die Tür des Mikrowellenherdes sammeln. Es ist ganz normal.
Der Mikrowellenherd wird ohne Essen in seinem Innen zufällig eingeschaltet	Das Funktionieren des Mikrowellenherdes für kurze Zeit ohne Essen in seinem Innen verursacht keine Schade. Es ist aber besser, diese Situation zu vermeiden.

Problem	Möglicher Grund	Lösung
Der Mikrowellenherd schaltet sich nicht ein	Das Speisekabel ist in der Steckdose nicht richtig eingeschaltet	Der Stecker aus der Steckdose ausschalten, nach 10 Sekunden wieder einschalten.
	Die Schmelzsicherung schlägt durch oder der Selbstschalter läuft an	Die Schmelzsicherung ersetzen oder den Selbstschalter wiedereinführen (repariert von Fachkräfte unserer Firma)
	Probleme mit dem Ausgang	Den Ausgang mit einem anderen Hausgerät kontrollieren
Der Mikrowellenherd wärmt nicht	Die Tür ist nicht richtig geschlossen	Die Tür richtig schließen
Die Glasplatte ist lärmend während des Funktionierens des Mikrowellenherdes	Schmutzige Walzen und Abfälle auf dem Boden des Mikrowellenherdes	Für die Reinigung der schmutzigen Teilen beziehen Sie sich auf den Abschnitt „Wartung des Mikrowellenherdes“

KUNDENDIENST – Wenn die Ursache der Störung nicht ausgemacht werden kann: Das Gerät ausschalten (das Gerät nicht beanspruchen) und sich mit dem Kundendienst in Kontakt setzen. **SERIENNUMMER** - Wo finde ich die Seriennummer? Bei der Kontaktaufnahme mit dem Kundendienst bitte die Artikel- und Seriennummer (16 Zeichen, beginnend mit der Ziffer 3) bereithalten, die auf der Garantie oder auf dem Typenschild des Geräts wiedergegeben sind. Dadurch ist es den Technikern möglich, Ihre Anfrage rascher zu bearbeiten und Sie sparen insbesondere Telefonkosten.



Dieses Gerät ist im Sinne der Europäischen Richtlinie 2002/96/EG über Elektro- und Elektronik-Altgeräte (WEEE) gekennzeichnet. Tragen Sie bitte dazu bei, dass dieses Produkt korrekt entsorgt und gehandhabt wird. Dies verhindert, dass die Umwelt belastet und die Gesundheit beeinträchtigt wird. Das auf dem Produkt wiedergegebene Kennzeichen weist darauf hin, dass es nicht wie normaler Haushaltsabfall entsorgt, sondern einer Sammelstelle für das Recycling von Elektro- und Elektronikgeräten zu übergeben ist. Das Gerät entsprechend den lokalspezifischen Umweltvorschriften für Altgeräte entsorgen. Weiter Informationen in Bezug auf die Behandlung, Wiederverwertung und das Recycling dieses Produkts erhalten Sie bei den Lokalbehörden, den Abfallentsorgungsunternehmen und der Verkaufsstelle, bei der Sie dieses Produkt erworben haben.

PN:16170000A41735

CANDY

فرن الميكروويف

كتيب التعليمات

الطراز: MIC 20G DFX

MIC 20G DFN

يُرجى قراءة هذه التعليمات بعناية قبل استخدام فرن الميكروويف والاحتفاظ بها بعناية. باتباع هذه التعليمات، تضمن إمكانية استخدام الفرن بحالة جيدة لسنوات عديدة.

احفظ هذه التعليمات بعناية

احتياطات لتفادي احتمالية التعرض لطاقة الميكروويف الزائدة

- (a) لا تعتمد إلى تشغيل هذا الفرن أثناء فتح الباب، حيث قد يؤدي ذلك إلى التعرض لطاقة الميكروويف الخطرة. من المهم ألا يتم كسر الأقفال الداخلية أو العبث بها.
- (b) لا تضع أي شيء بين واجهة الفرن الأمامية والباب أو تسمح بتراكم الأوساخ أو بقايا المنظفات على الأسطح العازلة.
- (c) تحذير: إذا تلف الباب أو مانع التسرب به، فيحظر تشغيل الفرن حتى يتم إصلاحه من قبل شخص مؤهل.

ملحق

إذا لم يتم الحفاظ على الجهاز في حالة جيدة من النظافة، فإن سطحه يمكن أن يتحلل، ويؤثر على عمر الجهاز، ويؤدي إلى حالة خطيرة.

المواصفات

MIC 20G DFX MIC 20G DFN	الطراز:
230 فولت~50 هرتز	الجهد المقدر:
1250 واط	قدرة الدخل المقدر (للميكروويف):
800 واط	قدرة الخرج المقدر (للميكروويف):
1000 واط	قدرة الدخل المقدر (الشواوية):
20L	سعة الفرن:
Ø245 مم	قطر القرص الدوار:
388×345×594 مم	الأبعاد الخارجية:
15 كجم تقريباً	الوزن الصافي:

تعليمات هامة للسلامة تحذير

لتفادي خطر اندلاع حريق أو حدوث صدمة كهربائية أو إصابة الأشخاص أو التعرض لطاقة الميكروويف المفرطة أثناء استخدام الجهاز، اتبع الإجراءات الوقائية، بما في ذلك ما يلي:

1. تحذير: يحظر تسخين السوائل والأطعمة الأخرى في أوعية محكمة الغلق نظرًا لأنها عرضة للانفجار.
2. تحذير: من الخطير قيام شخص غير مختص بإجراء أي أعمال صيانة أو إصلاح والتي تتضمن إزالة الغطاء الذي يحمي من التعرض لطاقة الميكروويف.
3. يُمكن أن يستخدم هذا الجهاز الأطفال البالغة أعمارهم 8 سنوات أو أكثر والأشخاص الذين يعانون نقصًا في القدرات البدنية، أو الحسية، أو العقلية، أو الأشخاص الذين لديهم نقص في الخبرة أو المعرفة إذا خضعوا للإشراف أو قُدمت لهم تعليمات بشأن استخدام الجهاز بطريقة آمنة وكان لديهم فهم للمخاطر التي ينطوي عليها. يجب ألا يلعب الأطفال بالجهاز. لا يجب أن يقوم الأطفال بأعمال التنظيف والصيانة إلا إذا تجاوز عمرهم 8 سنوات، وخضعوا للإشراف.
4. أبقِ الجهاز والسلوك بعيدًا عن متناول الأطفال الذين يقل عمرهم عن 8 سنوات.
5. استخدم الأواني الملائمة للاستخدام في فرن الميكروويف فقط.
6. ويجب تنظيف الجهاز بشكل منتظم وإزالة أي بقايا طعام.
7. اقرأ وتابع كما هو محدد: "الاحتياطات لتفادي احتمالية التعرض لطاقة الميكروويف الزائدة".
8. عند تسخين الأطعمة في الأوعية البلاستيكية أو الورقية، احرص على مراقبة الجهاز نظرًا لإمكانية اشتعال هذه الأوعية.

9. في حالة ملاحظة انبعاث دخان، قم بإيقاف التشغيل أو افصل الجهاز من مصدر التيار الكهربائي واترك الباب مغلقًا من أجل إخماد أي لهب.
10. لا تفرط في طهي الطعام.
11. لا تستخدم تجويف الفرن لأغراض التخزين.
- لا تقم بتخزين الأشياء، مثل الخبز والكعك، وما إلى ذلك داخل الفرن.
12. قم بإزالة الأسلاك الملتوية والمقابض المعدنية من الأوعية/الأكياس الورقية أو البلاستيكية قبل وضعها في الفرن.
13. قم بتركيب أو وضع هذا الفرن فقط بما يتوافق مع تعليمات التركيب المرفقة.
14. ولا يجب تسخين البيض بقشرته والبيض المسلوq في فرن الميكروويف نظرًا لأنه قد ينفجر حتى بعد إنهاء تسخين الفرن.
15. هذا الجهاز مصمم للاستخدام في المنزل والاستخدامات المماثلة مثل:
-مناطق مطبخ الموظفين في المحلات والمكاتب وبيئات العمل الأخرى؛
-بواسطة العملاء في الفنادق والأوتيلات والبيئات الأخرى من النوع السكني.
-منازل المزارعين؛
-البيئات التي بها أسرة وأماكن لتناول الفطور.
16. في حال تلف كابل التغذية، يجب استبداله بواسطة الشركة المصنعة، أو وكيل الخدمة الخاص بها أو الأشخاص المؤهلين بالدرجة نفسها لتفادي التعرض للخطر.
17. لا تقم بتخزين هذا الجهاز أو استخدامه في الهواء الطلق.
18. لا تستخدم هذا الفرن بالقرب من المياه أو في قبو مبثl أو بالقرب من حمام سباحة.
19. ربما ترتفع درجة حرارة الأسطح القريبة من الجهاز أثناء تشغيل الجهاز. وهذه الأسطح عرضة للسخونة أثناء الاستخدام. احتفظ بالكابل بعيدًا عن السطح الساخن وقم بتغطية أية فتحات تهوية على الفرن.

20. لا تترك الكابل معلقاً فوق حافة طاولة أو منضدة.
21. قد يؤدي عدم الحفاظ على الفرن نظيفاً إلى تدهور حالة السطح، مما قد يؤثر سلبيًا على عمر الجهاز، وربما ينطوي على خطورة.
22. يجب هز محتويات زجاجات الإرضاع وبرطمانات أطعمة الأطفال ويجب التحقق من درجات الحرارة قبل الاستخدام لتجنب الحروق.
23. يمكن أن يؤدي تسخين المشروبات في الميكروويف إلى استمرار غليانها بعض الوقت، فتوخ الحرص عند التعامل مع الوعاء.
24. هذا الجهاز غير مخصص للاستخدام من قبل الأشخاص الذين يعانون من نقص في القدرات البدنية أو الحسية أو الذهنية (بما في ذلك الأطفال) أو الذين لا يتمتعون بالخبرة والمعرفة، ما لم يتم الإشراف عليهم أو إعطائهم التعليمات المتعلقة بكيفية استخدام الجهاز من جانب شخص مسؤول عن سلامتهم.
25. يجب الإشراف على الأطفال للتأكد من أنهم لا يعبثون بالجهاز.
26. الأجهزة ليست مخصصة للاستخدام مع مؤقت خارجي أو نظام تحكم عن بعد منفصل.
27. قد تسخن الأجزاء التي يمكن الوصول إليها أثناء الاستخدام.
- يجب إبقاء الأطفال الصغار بعيدًا.
28. يجب عدم استخدام منظم البخار.
29. يصبح الجهاز ساخنًا أثناء الاستخدام. يجب توخي الحذر لتفادي لمس عناصر التسخين داخل الفرن.
30. استخدم فقط مجس الحرارة الموصي به لهذا الفرن. (للأفران المزودة بمرفق لاستخدام مجس استشعار درجة الحرارة).

31. تحذير: يصبح الجهاز والأجزاء التي يمكن الوصول إليها ساخنة أثناء الاستخدام. يجب توخي الانتباه لتجنب ملامسة العناصر الساخنة. يجب إبعاد الأطفال الذين هم دون سن 8 سنوات عن الجهاز ما لم يخضعوا للمراقبة المستمرة.
32. يجب تشغيل فرن الميكروويف وباب الزينة مفتوح (إن وجد). (للأفران المزودة بباب زينة).
33. يمكن أن يسخن سطح كابينة التخزين.

اقرأها بعناية واحتفظ بها للرجوع إليها مستقبلاً

للحد من خطر إصابة الأشخاص بتأريض التركيب

خطر

استشر الكهربائي أو فني الصيانة المؤهل إذا لم تكن تعليمات التأريض مفهومة تمامًا أو إذا كان هناك شك فيما إذا كان الجهاز مؤرض بشكل صحيح. إذا لزم الأمر استخدام كابل توصيل، فاستخدم فقط كابل توصيل ذو 3 أسلاك.

خطر التعرّض لصدمة كهربائية: قد يؤدي لمس بعض المكونات الداخلية إلى التعرّض لإصابة شخصية خطيرة أو الوفاة. يحظر فك هذا الجهاز.

تحذير

خطر حدوث صدمة كهربائية ربما يؤدي عدم التثبيت الأرضي الملائم للجهاز إلى حدوث صدمة كهربائية. لا تقم بتوصيل القابس حتى يتم تركيب الجهاز وتثبيته بشكل صحيح.

يجب تأريض هذا الجهاز. في حالة الدائرة الكهربائية القصيرة، فإن التثبيت بالأرضي يقلل من احتمالات حدوث صدمة كهربائية حيث يوفر سلماً لهروب التيار الكهربائي. تم تجهيز هذا الجهاز بسلك له موصل تأريض للأجهزة وقابس تأريض. يجب توصيل القابس بمنتفذ تم تركيبه وتأريضه بطريقة صحيحة.

1. مرفق بالجهاز كابل قصير للإمداد بالكهرباء لتقليل المخاطر التي قد تنجم عن التشابك أو التعثر بالكابل الأطول. 2. في حالة استخدام مجموعة كابل أطول أو كابل توصيل:
 - (1) لا بد أن يكون القياس الكهربائي المميز لمجموعة الكابل أو كابل التوصيل مماثلاً للقياس الكهربائي للجهاز على أقل تقدير.
 - (2) لا بد أن يكون كابل التوصيل هو كابل تأريض ذو 3 أسلاك.
 - (3) يجب تنظيم وضع الكابل الطويل بحيث لا ينسدل فوق سطح المنضدة أو الطاولة أو يتسنى للأطفال جذبه أو التعثر به دون قصد.

التنظيف

احرص على فصل الجهاز عن مصدر التيار الكهربائي.

1. نظف تجويف الفرن بعد الاستخدام بقطعة قماش مبللة قليلاً.
2. نظف الملحقات بالطريقة المعتادة بالماء والصابون.
3. يجب تنظيف إطار الباب ومانع التسرب الخاص به والأجزاء المجاورة بعناية في حالة اتساخها باستخدام قطعة قماش مبللة.
4. لا تستخدم منظفات كاشطة أو ممسحات معدنية حادة لتنظيف الباب الزجاجي للفرن نظرًا لأنها قد تخدش السطح، مما قد يؤدي إلى تهشم الزجاج.
5. نصيحة تنظيف --- لتنظيف أسهل من أجل جدران التجويف التي يلامسها الطعام المطهي: ضع نصف ليمونة في وعاء، أضف 300 مل ماء (1/2 باينت) وقم بتسخينها على طاقة ميكروويف 100% لمدة 10 دقائق. امسح الفرن لتنظيفه باستخدام قطعة قماش جافة وناعمة.

الأواني

تنبيه

خطر إصابة الأشخاص

انظر التعليمات الواردة في "المواد التي يمكن استخدامها أو يجب تجنب استخدامها في فرن الميكروويف". قد يكون هناك بعض الأواني غير المعدنية التي ليست آمنة لاستخدامها في الميكروويف. إذا ساورك الشك، يمكنك اختبار الأواني المعنية باتباع الإجراء أدناه

من الخطير قيام شخص غير مختص بإجراء أي أعمال صيانة أو إصلاح والتي تضمن إزالة الغطاء الذي يحمي من التعرض لطاقة الميكروويف.

اختبار الإناء:

1. قم بملء حاوية ميكروويف آمنة بكوب (1) من الماء البارد (250 مل) بالإضافة للإناء ذي الصلة.
2. قم بتشغيل الفرن بأقصى طاقة لمدة دقيقة (1).
3. المس الإناء بحرص. إذا كان الإناء الفارغ دافئًا، فلا تستخدمه في الطهي داخل فرن الميكروويف.
4. يجب ألا تتجاوز مدة الطهي (1) دقيقة.

المواد التي يمكن استخدامها في فرن الميكروويف

ملاحظات	الأواني
الحماية فقط. يمكن استخدام القطع الصغيرة الملساء لتغطية الأجزاء الرقيقة من اللحم أو الدواجن تفادياً لتعرضها للطهي الزائد. يمكن أن يحدث التقوس إذا كانت الرقائق قريبة جداً من جدران الفرن. يجب أن تكون الرقاقة على بُعد 1 بوصة (2.5 سم) على الأقل من جدران الفرن.	رقائق ألومنيوم
اتبع إرشادات جهة التصنيع. يجب وضع قاعدة صحن التحمير على مسافة 3/16 بوصة (5 مم) على الأقل فوق القرص الدوّار. قد يؤدي الاستخدام غير الصحيح إلى كسر القرص الدوّار.	صحن التحمير
الأمنة لفرن الميكروويف فقط. اتبع إرشادات جهة التصنيع. لا تستخدم الصحن المشروخة أو المكسورة. احرص دائماً على نزع الغطاء. استخدمها فقط لتسخين الطعام حتى يصبح دافئاً فقط. معظم البرطمانات الزجاجية ليست مقاومة للحرارة وقد تنكسر.	أدوات المائدة البرطمانات الزجاجية
فقط أواني الفرن الزجاجية المقاومة للحرارة. تأكد من خلوها من الأجزاء المعدنية. لا تستخدم الصحن المشروخة أو المكسورة.	الأواني الزجاجية
اتبع إرشادات جهة التصنيع. تجنب إغلاقها باستخدام رابط معدني. قم بعمل فتحات للسماح بانبعث البخار. الأطباق والأكواب	أكياس الطهي
استخدمها في الطهي قصير الأمد/التدفئة فقط. لا تترك الفرن بدون رقابة أثناء الطهي.	الورقية
استخدمها لتغطية الطعام عند إعادة تسخينه ولامتصاص الدهون. استخدمها مع الإشراف عند الطهي لمدة قصيرة فقط.	المناشف الورقية
استخدمه كغطاء للحيلولة دون تناثر الطعام أو لتغطيته عند الطهي بالبخار.	ورق الطهي
الأمنة لفرن الميكروويف فقط. قم باتباع إرشادات جهة التصنيع. يجب أن يكون مدون عليها ما يفيد باستخدامها الآمن في أفران الميكروويف. بعض الحاويات البلاستيكية تصبح أكثر رقة عندما يسخن الطعام بداخلها. "أكياس السلق" والأكياس البلاستيكية المغلقة بإحكام ينبغي أن تكون مشقوفة أو مثقوبة أو ذات فتحة تهوية وفقاً لتوجيهات الطرد.	البلاستيك
الأمنة لفرن الميكروويف فقط. استخدمها لتغطية الطعام أثناء الطهي للحفاظ على الرطوبة. لا تدع الغطاء البلاستيكي يلمس الطعام.	الأغطية البلاستيكية
فقط التي يمكن استخدامها بأمان داخل فرن الميكروويف (موازين الحرارة الخاصة بالحوم والحلوى). استخدمه كغطاء للحيلولة دون تناثر الطعام والحفاظ على رطوبته.	موازين الحرارة ورق الشمع

المواد التي ينبغي تجنب وضعها في فرن الميكروويف

ملاحظات	الأواني
ربما يحدث لها تقوس. انقل الطعام إلى طبق آمن الاستخدام داخل أفران الميكروويف.	صينية ألومنيوم
ربما يحدث لها تقوس. انقل الطعام إلى طبق آمن الاستخدام داخل أفران الميكروويف.	أواني الطعام المصنوعة من الكرتون والمزودة بمقبض معدني
يعمل المعدن على عزل الطعام عن طاقة الميكروويف. ربما تتسبب الأجزاء المعدنية في التقوس.	الأواني المعدن أو ذات الأجزاء المعدنية
ربما تتسبب في حدوث تقوس واندلاع حريق بداخل الفرن.	الأربطة السلكية المعدنية
ربما تتسبب في اندلاع حريق بداخل الفرن.	الأكياس الورقية
ربما تنصهر أواني القوم البلاستيكية أو تُلوث السائل الموجود بداخلها عند تعرضها لدرجات الحرارة العالية.	أواني القوم البلاستيكية
يجف الخشب عند استخدامه بداخل فرن الميكروويف وربما يتشقق أو ينكسر.	الخشب

إعداد الفرن

أسماء أجزاء وملحقات الفرن

أخرج الفرن وكافة المواد من العبوة الكرتونية وتجويف الفرن.
يأتي الفرن مرفقًا بالملحقات التالية:

- 1 صينية زجاجية
1 مجموعة القرص الدوار
1 كتيب التعليمات

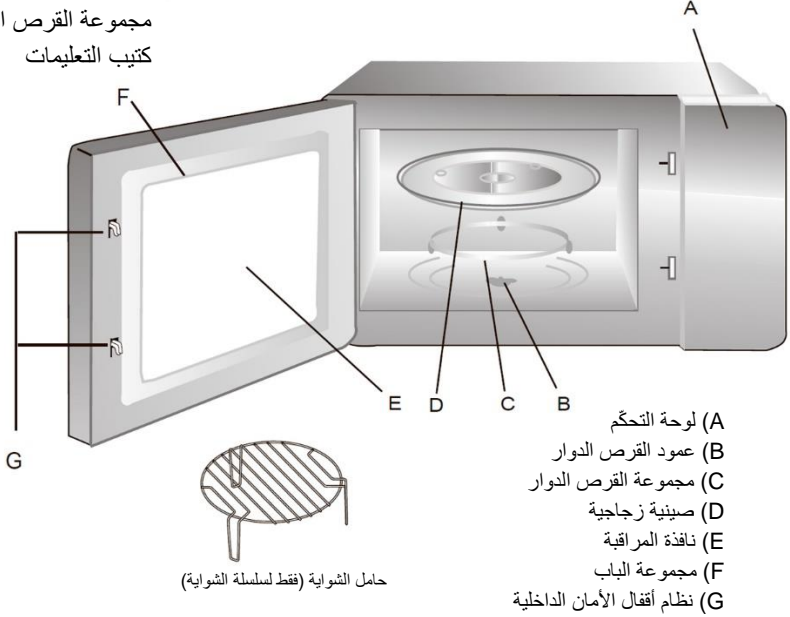

تركيب القرص الدوار

المحور (الجزء السفلي)

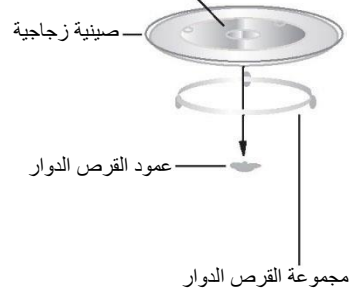

- a. لا تضع الصينية الزجاجية بالشكل المقلوب. لا يجب تثبيت الصينية الزجاجية على الإطلاق.
b. يجب دائمًا استخدام كل من الصينية الزجاجية ومجموعة القرص الدوار أثناء الطهي.
c. يجب دائمًا وضع كافة الأطعمة وأوعية الأطعمة على صينية زجاجية لأجل الطهي.
d. في حالة وجود شرخ أو كسر في الصينية الزجاجية أو مجموعة القرص الدوار، اتصل بأقرب مركز خدمة معتمد.

التركيب والتوصيل

1. هذا الجهاز مخصص للاستخدام المنزلي فقط.
2. هذا الفرن مخصص للاستخدام الذاتي فقط. إنه غير مخصص لاستخدامه على المنضدة أو للاستخدام داخل الخزانة.
3. يرجى مراعاة إرشادات التركيب الخاصة.
4. يمكن تركيب الجهاز في خزانة مثبتة على الجدران بعرض 60 سم (على الأقل بعمق 55 سم و85 سم عن الأرض).
5. تم تزويد الجهاز بقابس ويجب توصيله بمقبس مثبت ومؤرض بشكل صحيح.
6. يجب أن يتوافق الجهد الرئيسي مع الجهد المحدد في لوحة التصنيف.
7. يجب تركيب المقبس ويجب استبدال كابل التوصيل بواسطة كهربائي مؤهل فقط. في حالة عدم القدرة على الوصول إلى القابس بعد التركيب، يجب أن يكون جهاز الفصل بكل الأقطاب موجودًا على جانب التركيب مع وجود فجوة تلامس لا تقل عن 3 مم.
8. يجب عدم استخدام المهابئات، والشرائط متعددة المسالك ووصلات التمديد. قد تؤدي زيادة الحمل إلى خطر نشوب حريق.



قد يسخن السطح الخارجي أثناء التشغيل.

تعليمات التشغيل

1. ضبط الساعة

بمجرد توصيل فرن الميكروويف، سيرعرض مؤشر "0:00" LED، وسيبرن الجرس مرة واحدة.

(1) اضغط "⏸️ | ⏹️" ، وستومض أرقام الساعات.

(2) أدر "⏸️" لضبط أرقام الساعات، يجب أن يكون وقت الإدخال بين 0--23.

(3) اضغط "⏸️ | ⏹️" ، وستومض أرقام الدقائق.

(4) أدر "⏸️" لضبط أرقام الدقائق، يجب أن يكون وقت الإدخال بين 0--59.

(5) اضغط "⏸️ | ⏹️" لإنهاء ضبط الساعة. سيومض ":" وسيضيء الوقت.

ملاحظة: (1) إذا لم يتم ضبط الساعة، فلن تعمل عند تشغيلها.

(2) أثناء عملية ضبط الساعة، إذا ضغطت "STOP" ⏹️، سيعود الفرن إلى الحالة السابقة تلقائيًا.

2. الطهي بطاقة الميكروويف

اضغط على "⏸️ | ⏹️ | ⏸️" ، وسيعرض مؤشر P100 LED. اضغط على "⏸️ | ⏹️ | ⏸️" لعدد من المرات أو أدر

"⏸️" لاختيار الطاقة التي تريدها، وسيتم عرض "P100" أو "P80" أو "P50" أو "P30" أو "P10" لكل ضغطة مضافة. ثم

اضغط على "⏸️ +30" للتأكيد وأدر "⏸️" لضبط وقت الطهي من 0:05 حتى 95:00. اضغط على "⏸️ +30" مرة أخرى لبدء الطهي.

مثال: إذا كنت تريد استخدام قدرة الميكروويف بنسبة 80% للطهي لمدة 20 دقيقة، فيمكنك تشغيل الفرن باتباع الخطوات التالية.

(1) اضغط على "⏸️ | ⏹️ | ⏸️" مرة واحدة، وستعرض الشاشة "P100".

(2) اضغط على "⏸️ | ⏹️ | ⏸️" مرة أخرى أو أدر "⏸️" لاختيار 80% من قدرة الميكروويف.

(3) اضغط على "⏸️ +30" للتأكيد، وستعرض الشاشة "P 80".

(4) أدر "⏸️" لضبط وقت الطهي حتى يعرض الفرن "20:00".

(5) اضغط "⏸️ +30" لبدء الطهي.







ملاحظة: خطوة الكميات للوقت المضبوط بالمفاتيح الكودية هي كما يلي:

0---1	الحد الأدنى	: 5 ثوانٍ
1—5	الحد الأدنى	: 10 ثوانٍ
5---10	الحد الأدنى	: 30 ثوانٍ
10---30	الحد الأدنى	: 1 دقيقة
30---95	الحد الأدنى	: 5 دقائق

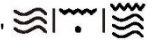

الطلب	تعليمات المنصة الشاشة	قدرة الميكروويف	قدرة الشواوية
1	P100	%100	
2	P80	%80	
3	P50	%50	
4	P30	%30	
5	P10	%10	
6	G	%0	%100
7	C-1	%55	%45
8	C-2	%36	%64

3. الشواوية أو مجموعة الفرن. الطهي

اضغط على  " مرة واحدة، ويتم عرض "P100" ثم اضغط على  " لعدد من المرات أو أدر  " لاختيار القدرة التي تريدها، وسيتم عرض "G" أو "C-1" أو "C-2" لكل ضغطة مضافة. ثم اضغط على  "+30" " للتأكيد وأدر  " لضبط وقت الطهي من 0:05 إلى 95:00. اضغط على  "+30" " مرة أخرى لبدء الطهي.

مثال: إذا كنت ترغب في استخدام 55% من قدرة الميكروويف و45% من قدرة الشواوية (C-1) للطهي لمدة 10 دقائق، فيمكنك تشغيل الفرن باتباع الخطوات التالية.

1) اضغط على  " مرة واحدة، وستعرض الشاشة "P100".

2) اضغط على  " لعدد من المرات أو أدر  " لاختيار مجموعة الفرن. الوضع 1.



3) اضغط على  "+30" " للتأكيد، وستعرض الشاشة "C-1".



4) أدر  " لضبط وقت الطهي حتى يعرض الفرن "10:00".

5) اضغط  "+30" " لبدء الطهي.

ملاحظة: إذا مر نصف وقت الشواء، يصدر الفرن صوتاً مرتين، وهذا أمر طبيعي. من أجل الحصول على تأثير أفضل لشوي الطعام، يجب قلب الطعام وإغلاق الباب وبعد ذلك في حالة عدم التشغيل، سيستمر الفرن في الطهي.

4. بدء التشغيل السريع

- (1) في حالة الانتظار، اضغط على "  +30" " لبدء الطهي بقدرة 100%، وستزيد كل ضغطة مضافة من وقت الطهي لمدة تتراوح من 30 ثانية إلى 95 دقيقة.
- (2) في الميكروويف، أو الشواية، أو مجموعة الفرن، أو الطهي أو حالة وقت تسخين الطعام، يمكن أن تؤدي كل ضغطة على "  +30" " إلى زيادة وقت الطهي بمقدار 30 ثانية.

- (3) في حالة الانتظار، أدر "  " في عكس اتجاه عقارب الساعة لضبط وقت الطهي بمقدار 100% من قدرة الميكروويف، ثم اضغط على "  +30" " لبدء الطهي.

5. تسخين الطعام حسب الوزن

- (1) اضغط على "  " لاختيار وزن الطعام من 100 إلى 2000 جم.

- (2) أدر "  " لاختيار وزن الطعام من 100 إلى 2000 جم.

- (3) اضغط "  +30" " لبدء تسخين الطعام.

6. تسخين الطعام حسب الوقت

- (1) اضغط على "  " مرتين، وسيعرض الفرن "dEF2".

- (2) أدر "  " لاختيار وقت تسخين الطعام.

- (3) اضغط "  +30" " لبدء تسخين الطعام.

7. القائمة التلقائية

- (1) أدر "  " ناحية اليمين لاختيار القائمة، وسيظهر "A-1" إلى "A-10"، وهو ما يشير إلى البييتزا والبطاطس واللحوم والأسماك والخضروات والمشروبات والمعكرونة والفشار والدجاج وإعادة التسخين.

- (2) اضغط على "  +30" " للتأكيد.

- (3) أدر "  " لاختيار الوزن الافتراضي كمخطط القائمة.

- (4) اضغط "  +30" " لبدء الطهي.

مثال: إذا كنت تريد استخدام "القائمة التلقائية" لطهي السمك بوزن 350 جم.

- (1) أدر "  " في اتجاه عقارب الساعة حتى يتم عرض "A-4".

- (2) اضغط على "  +30" " للتأكيد.

- (3) أدر "  " لتحديد وزن السمك حتى يتم عرض "350".

- (4) اضغط "  +30" " لبدء الطهي.

































































































































































































































































































































































































القائمة	الوزن	الشاشة
A-1	200 جم	200 جم
	400 جم	400 جم
A-2	200 جم	200 جم
	400 جم	400 جم
	600 جم	600 جم
A-3	250 جم	250 جم
	350 جم	350 جم
	450 جم	450 جم
A-4	250 جم	250 جم
	350 جم	350 جم
	450 جم	450 جم
A-5	200 جم	200 جم
	300 جم	300 جم
	400 جم	400 جم
A-6	1 كوب (120 مل)	1
	كوبان (240 مل)	2
	3 أكواب (360 مل)	3
A-7	50 جم (450 مل من الماء البارد)	50 جم
	100 جم (800 مل من الماء البارد)	100 جم
A-8	50 جم	50 جم
	100 جم	100 جم
A-9	200 جم	200 جم
	400 جم	400 جم
	600 جم	600 جم
	800 جم	800 جم
A-10	200 جم	200 جم
	400 جم	400 جم
	600 جم	600 جم

8. تم تعيين البرنامج مقدماً

(1) اضبط الساعة أولاً. (راجع تعليمات ضبط الساعة).

(2) أدخل برنامج الطهي. يمكن تعيين مرحلتين على الأكثر. لا يجب ضبط تسخين الطعام كبرنامج للطهي.

مثال: إذا كنت تريد الطهي باستخدام 80% من قدرة الميكروويف لمدة 7 دقائق، فقم بتشغيله على النحو التالي:

a. اضغط على "  |  |  |  |  |  |  |  |  |  |  |  |  |  |  |  |  |  |  |  |  |  |  |  |  |  |  |  |  |  |  |  |  |  |  |  |  |  |  |  |  |  |  |  |  |  |  |  |  |  |  |  |  |  |  |  |

 |  |  |  |  |  |  |  |  |  |  |  |  |  |  |  |  |  |  |  |  |  |  |  |  |  |  |  |  |  |  |  |  |  |  |  |  |  |  |  |  |  |  |  |  |  |  |  |  |  |  |  |  |  |  |  |  |

 |  |  |  |  |  |  |  |  |  |  |  |  |  |  |  |  |  |  |  |  |  |  |  |  |  |  |  |  |  |  |  |  |  |  |  |  |  |  |  |  |  |  |  |  |  |  |  |  |  |  |  |  |  |  |  |  |

 |  |  |  |  |  |  |  |  |  |  |  |  |  |  |  |  |  |  |  |  |  |  |  |  |  |  |  |  |  |  |  |  |  |  |  |  |  |  |  |  |  |  |  |  |  |  |  |  |  |  |  |  |  |  |  |  |

 |  |  |  |  |  |  |  |  |  |  |  |  |  |  |  |  |  |  |  |  |  |  |  |  |  |  |  |  |  |  |  |  |  |  |  |  |  |  |  |  |  |  |  |  |  |  |  |  |  |  |  |  |  |  |  |  |

 |  |  |  |  |  |  |  |  |  |  |  |  |  |  |  |  |  |  |  |  |  |  |  |  |  |  |  |  |  |  |  |  |  |  |  |  |  |  |  |  |  |  |  |  |  |  |  |  |  |  |  |  |  |  |  |  |

 |  |  |  |  |  |  |  |  |  |  |  |  |  |  |  |  |  |  |  |  |  |  |  |  |  |  |  |  |  |  |  |  |  |  |  |  |  |  |  |  |  |  |

c. اضغط على " +30"  للتأكيد، وستعرض الشاشة "P 80".

d. أدر "  لضبط وقت الطهي حتى يعرض الفرن "7:00".

بعد تنفيذ الخطوات السابقة، احرص على عدم الضغط على " +30"  لبدء الطهي.

3) اضغط "  "، وستومض أرقام الساعات.

4) أدر "  لضبط أرقام الساعات، يجب أن يكون وقت الإدخال بين 23--0.

5) اضغط "  "، وستومض أرقام الدقائق.



6) أدر "  لضبط أرقام الدقائق، يجب أن يكون وقت الإدخال بين 59--0.

7) اضغط على " +30"  لإنهاء الضبط. إذا كان الباب مغلقاً، سيرن الجرس مرتين عندما يحين الوقت، ثم سيبدأ الطهي تلقائياً.



9. الطهي متعدد الأقسام





يمكن ضبط قسمين على الأكثر للطهي. في الطهي متعدد الأقسام، إذا كان أحد الأقسام يقوم بتسخين الطعام، فيجب وضع تسخين الطعام في القسم الأول.

مثال: إذا كنت تريد تسخين الطعام لمدة 5 دقائق ثم الطهي باستخدام 80% من قدرة الميكروويف لمدة 7 دقائق، فقم بتشغيله على النحو التالي:

1) اضغط على "  |  |  " مرتين، وسيعرض الفرن "dEF2".

2) أدر "  لاختيار وقت تسخين الطعام حتى يتم عرض "5:00".

3) اضغط على "  |  |  " مرة واحدة، وستعرض الشاشة "P100".



4) اضغط على "  |  |  " مرة أخرى أو أدر "  لاختيار 80% من قدرة الميكروويف.

5) اضغط على " +30"  للتأكيد، وستعرض الشاشة "P 80".



6) أدر "  لضبط وقت الطهي حتى يعرض الفرن "7:00".

7) اضغط على " +30"  لبدء الطهي، وسوف يصدر صوت الجرس مرة واحدة للقسم الأول، ويتم العد التنازلي لوقت تسخين الطعام؛ سيصدر صوت الجرس مرة أخرى عند دخوله إلى قسم الطهي الثاني. عند الانتهاء من الطهي، يصدر صوت الجرس خمس مرات.

10. وظيفة الاستعلام

- (1) في حالة استخدام الميكروويف والشواية والطهي المجمع، اضغط على "  "، وسيتم عرض الفترة الحالية لمدة 3 ثوانٍ. بعد 3 ثوانٍ، سيعود الفرن إلى حالته السابقة؛
- (2) في حالة الطهي، اضغط على "  " للاستعلام عن الوقت وسيتم عرض الوقت لمدة 3 ثوانٍ.
- (3) في حالة الضبط المسبق، اضغط على "  " للاستعلام عن الوقت المضبوط مسبقًا، وسيتم عرض الوقت المضبوط مسبقًا لمدة 3 ثوانٍ.

11. وظيفة القفل لحماية الأطفال

- القفل: في حالة الانتظار، اضغط على "  STOP " لمدة 3 ثوانٍ، سيصدر صوت تنبيه طويل يشير إلى الدخول في حالة قفل الأطفال وسيتم عرض الوقت الحالي إذا تم ضبط الوقت، وإلا فسيعرض مؤشر "  LED ".
- إلغاء القفل: في حالة القفل، اضغط على "  STOP " لمدة 3 ثوانٍ، وستسمع صوت "صفارة" طويل يدل على إلغاء القفل.

استكشاف الأعطال وإصلاحها

إذا كان هناك شيء ما يعمل على استكشاف الأعطال وإصلاحها؛ قبل طلب المساعدة، قم بإجراء الفحوصات التالية أولاً.

عادي	
ربما يتم التشويش على استقبال بث الراديو والتلفاز أثناء تشغيل الميكروويف. وهو مماثل للتشويش الذي تحدثه بعض الأجهزة الكهربائية الصغيرة، مثل الخلاط والمكنسة الكهربائية والمروحة الكهربائية. ويعد أمرًا طبيعيًا.	فرن الميكروويف يسبب تشويشًا على إرسال التلفاز
عند الطهي بطاقة الميكروويف المنخفضة، قد تصبح إضاءة الفرن خافتة. ويعد أمرًا طبيعيًا.	مصباح الفرن خافت
أثناء الطهي، قد ينبعث البخار من الطعام. ستخرج معظمها من فتحات التهوية. لكن بعضه قد يتراكم على مكان بارد مثل باب الفرن. ويعد أمرًا طبيعيًا.	تكتف البخار على الباب وخروج هواء ساخن من فتحات التهوية
يحظر تشغيل الوحدة دون وجود طعام بداخلها. حيث يمثل ذلك خطورة كبيرة.	تشغيل الفرن بالخطأ بدون وجود طعام بداخله

المشكلة	السبب المحتمل	الحل
تعذر تشغيل الفرن.	(1) كابل الطاقة ليس موصلًا بإحكام.	افصله عن مصدر الكهرباء. ثم أعد توصيله بعد مرور 10 ثوان.
	(2) احترق المصهر أو قاطع الدائرة الكهربائية قيد التشغيل.	استبدل المصهر أو أعد تعيين قاطع الدائرة الكهربائية (يجب أن يتم الاستبدال على يد طاقم متخصص معتمد من شركتنا)
	(3) توجد مشكلة بمأخذ التيار الكهربائي.	اختبر مأخذ التيار الكهربائي مع أجهزة كهربائية أخرى.
الفرن لا يقوم بالتسخين.	(4) الباب غير مغلق جيدًا.	أغلق الباب جيدًا.
يصدر القرص الدوار الزجاجي ضوضاء عند تشغيل فرن الميكروويف	(5) بقية البكرة المتسخة والجزء السفلي من الفرن.	راجع "صيانة الميكروويف" لتنظيف الأجزاء المتسخة.

خدمة مساعدة العملاء

إذا لم تتمكن من تحديد سبب مشكلة التشغيل: قم بإيقاف تشغيل الجهاز (لا تقم بمحاولات إصلاح متطرفة) واتصل بخدمة المساعدة.

الرقم المتسلسل للمنتج أين يمكنك العثور عليه؟

من المهم إبلاغ خدمة المساعدة برمز المنتج ورقمه التسلسلي (رمز مكون من 16 حرفًا يبدأ بالرقم 3)؛ ويمكن العثور عليه في شهادة الضمان أو على لوحة البيانات الموجودة على الجهاز.

سوف يساعد هذا على تجنب إهدار للوقت، وبالتالي (والأهم من ذلك) توفير رسوم وسيلة الشرح المقابلة.

تم اعتماد هذا الجهاز وفقاً للتوجيه الأوروبي رقم 2002/96/EC بشأن النفايات الكهربائية والأجهزة الإلكترونية (WEEE). من خلال التأكد من أن هذا المنتج يتم التخلص منه بصورة صحيحة، فأنت تساعد في الحد من حدوث العواقب السلبية المحتملة المؤثرة على البيئة وصحة الإنسان، والتي يمكن أن تنتج بسبب التعامل مع نفايات هذا المنتج بطريقة غير مناسبة. حيث يُشير الرمز الموجود على المنتج إلى أنه لا يجوز التعامل مع هذا المنتج كنفايات منزلية.



وبدلاً من ذلك، يجب تسليمها إلى نقطة التجميع المناسبة لإعادة تدوير المعدات الكهربائية والإلكترونية. ويجب أن يتم التخلص من النفايات وفقاً للوائح البيئية المحلية للتخلص من النفايات. للحصول على مزيد من المعلومات التفصيلية حول معالجة هذا المنتج واسترداده وإعادة تدويره، يُرجى الاتصال بمكتب المدينة المحلي لديك، أو خدمة التخلص من النفايات المنزلية لديك، أو المتجر الذي اشتريته منه المنتج.

PN:16170000A41735